

## **SPBR arquitetos**

Faria Lima, 1234 - 121  
São Paulo - SP 01451 913  
Brazil  
T + 55 11 3815 1171  
[www.spbr.arq.br](http://www.spbr.arq.br)

SPBR is an architecture office established in São Paulo, Brazil. It was founded in 2003 by Angelo Bucci.

For over 25 years, Angelo Bucci has been dedicated to building design, sharing his time between both professional and academic duties. These parallel activities define a special approach to SPBR projects, in which the professional demands are understood as an engaging opportunity to research and speculate new ideas.

Our projects highlight the importance of structural accuracy and distinctness, construction viability, transparency, and most importantly, a comprehension of the urban space as a democratic experience.

SPBR has been working worldwide with a great variety of projects on different scales and programs: apartment buildings, schools, cultural centers and multiple competitions. For each work, we activate our professional and academic network in order to gather the best expertises according to the design requirements.





## **Angelo Bucci**

Born in Orlandia – SP, October, 17th, 1963

Architect by University of São Paulo, 1987  
Master Degree, 1998 and PhD, 2005, by University of São Paulo  
Honorary Fellow of the American Institute of Architects (HF AIA), 2011

SPBR Arquitectos founder and principal in charge since 2003

### **PhD Professor at the University of São Paulo FAU USP, since 2001**

Eero Saarinen Visiting Professor at Yale – New Haven, CT, US, 2013  
Jury - Holcim International Sustainable Construction Award, 2011  
Visiting Professor at Di Tella University – Buenos Aires, Argentina, 2010  
Visiting Professor at UT Austin – Austin, TX, US, 2010  
Visiting Professor at IUAV summer workshop – Venice, Italy, 2008 and 2009  
Visiting Professor at MIT – Cambridge MA, US, 2008  
Visiting Professor at GSD Harvard – Cambridge MA, US, 2008  
Visiting Professor at UC Berkeley – Berkeley CA, US, 2006  
Visiting Professor at Torcuato Di Tella University – Buenos Aires, Argentina, 2006  
Visiting Professor at University of Cuenca - Cuenca, Ecuador 2005 and 2007  
Visiting Professor at ASU – Tempe AZ, US, 2005.  
Visiting Professor at Andres Bello University - Santiago, Chile, 2006

### **1. LECTURES**

Pamplona Biennial [Spain, 2013]; Honk Kong University [Hong Kong, 2013]; Merida Yucatan [Mexico, 2013]; Yale School of Architecture [New Haven, 2013]; TU Delft [Nederland, 2013]; GSD Harvard [Cambridge 2012]; Princeton University [New Jersey 2012], Columbia University – New York [New York, 2012], Shenzhen Biennial – Shenzhen [China, 2012]; University of Istanbul – Istanbul [Turkey 2012]; Venice Biennial and IUAV – Venice [Italy, 2012]; Mendoza Biennial, Mendoza [Argentina, 2012]; Luigi Snozzi lecture series in Monte Carasso [Zwitzerland, 2011], Durban and Pretoria [South Africa, 2011], AIA Convention New Orleans [New Orleans, 2011], Coimbra and Lisbon [Portugal, 2011], University of Parma [Italy, 2010]; International Institute of Architecture in Vico Morcote [Switzerland, 2010], UT Austin [Austin, 2009]; Academy of Architecture of Mendrisio [Switzerland, 2009], ETH Zurich [Zwitzerland, 2009]; AUT Architektur und Tirol in Innsbruck [Austria, 2009]; Universidade de Navarra in Pamplona [Spain, 2009]; Columbia University [New York, 2008]; Rice University [Houston, 2008]; Catholic University of Lima [Peru, 2007]; GSD Harvard [Cambridge 2007]; University of Santa Fé [Argentina, 2007]; Polytechnic University of Porto Rico [Porto Rico, 2007]; Catholic University of Cordoba [Argentina, 2007]; UC Berkeley [San Francisco 2005]; Universidad Andrés Bello in Santiago [Chile 2005]; Arizona State University [Phoenix 2005]; The Bartlett Architecture School of London [England 2004]; Universidad Nacional Autónoma de México [Mexico, 2004]; Woodbury University [Los Angeles and San Diego, 2003]; Arquine Conference in Mexico City [Mexico, 2002]; Universidad de La Coruña [Spain 2001]

### **Colaborations**

Architect Paulo Mendes da Rocha 1996 - 2002  
Eduardo de Almeida arquitetos 1994 - 1995  
Architect Marcelo Fragelli 1988 - 1989  
Aflalo e Gasperini arquitetos 1987 – 1988



## **CIRO MIGUEL**

São Paulo, 1980

Architect by University of São Paulo, 2004.  
Master in Architecture by Columbia University, 2008.  
SPBR arquitetos associate since 2006, collaborated since 2003.  
Architect at Bernard Tschumi Architects [NY] from 2008 to 2010.



## **JULIANA BRAGA**

São Paulo, 1977

Architect by University of São Paulo, 2004.  
Master Architect by the same institution, 2010.  
SPBR arquitetos associate since 2006, collaborated since 2003.



**TATIANA OZZETTI**

São Paulo, 1983

Architect by University of São Paulo, 2009.  
SPBR arquitetos associate since 2011, colaborated since 2007.

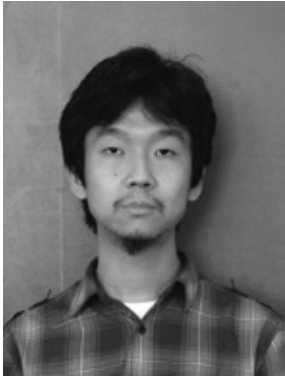

**NILTON SUENAGA**

Gabriel Monteiro, 1987

Architect by University of São Paulo, 2010.  
SPBR arquitetos associate since 2011, colaborated since 2009.

## **PRIZES**

### **2010**

Arquitetura e Construção Magazine – Beach House  
Casa em Ubatuba, Ubatuba, SP, Brazil

### **2009**

International Young Generation, XII Architecture International Biennial of Buenos Aires

### **2008**

Arquitetura e Construção Magazine – Urban House  
Casa em Santa Teresa, Rio de Janeiro, RJ, Brazil

### **2008**

SILVER at Latin America Holcim Awards  
Mediatheque PUC Rio, Rio de Janeiro, RJ, Brazil

### **2007**

HONOURABLE MENTION - VII BIASP Architecture International Biennial of Sao Paulo  
House in Santa Teresa, Rio de Janeiro, RJ, Brazil

### **2006**

FIRST PRIZE – Competition for the PUC Rio Mediatheque, Rio de Janeiro, RJ, Brazil

### **2003**

HONOURABLE MENTION - V BIASP Architecture International Biennial of Sao Paulo  
House in Ribeirão Preto, Ribeirão Preto, SP, Brazil

### **2002**

FIRST PRIZE - National Competition for the Republic's Memorial in Piracicaba

### **2002**

Brazilian Institute of Architects AWARD  
House in Ribeirão Preto, Ribeirão Preto, SP, Brazil.

### **2001**

THIRD PRIZE - National Competition for CREA - CE Headquarters

### **2000**

HONOURABLE MENTION - National Competition for The School of Medicine Renewal of the University of São Paulo

### **2000**

EX AEQUO PRIZE - IV Architecture International Biennial of Sao Paulo – Trianon Parking

### **2000**

NOMINEE for the Mies van der Rohe Prize - Psychological Clinic in Orlandia

### **1996**

HONOURABLE MENTION – 3rd Young Architect's Prize - Pousada in Juquehy

### **1991**

FIRST PRIZE - National Competition for the Brazilian Pavilion for the EXPO 92 in Seville, Spain.



# OLGA BAETA HOUSE RENOVATION

1997 São Paulo, SP

**ORIGINAL PROJECT** Vilanova Artigas, 1957

**ARCHITECTURE** Angelo Bucci

**DESIGN TEAM** Fernando de Mello Franco, Marta Moreira, Milton Braga  
Alvaro Puntoni, Carmen Morais, Luciana Itikama





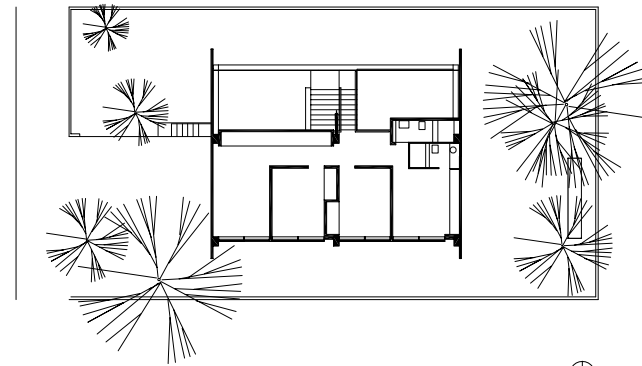
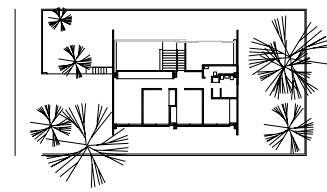
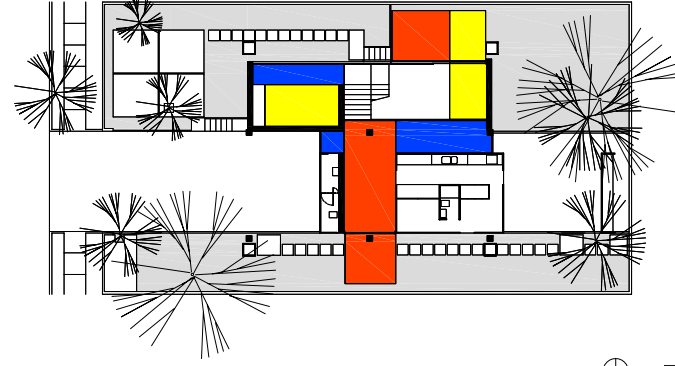
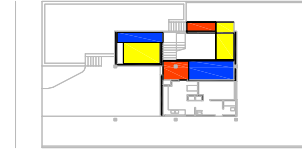

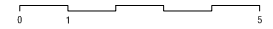
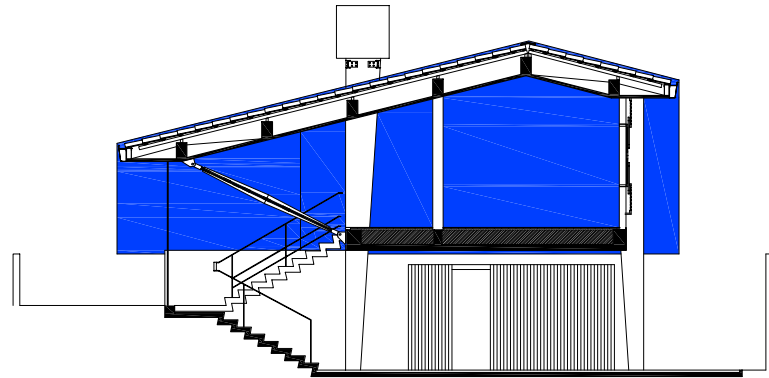
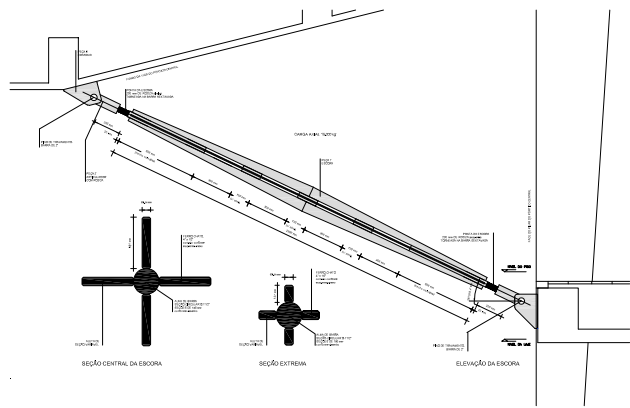





**PSYCHOLOGY CLINIC**

1998 Orlandia, SP

**ARCHITECTURE** Angelo Bucci

**AWARDS**

Mies Van der Rohe Awards Nominee 2000



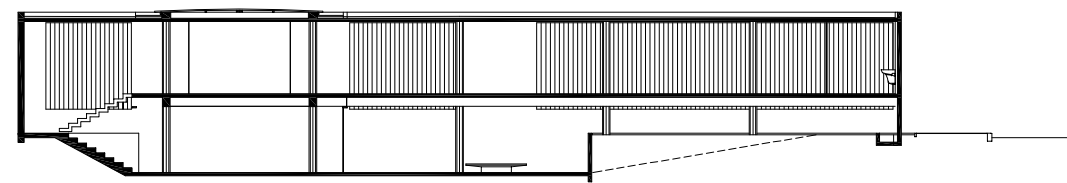
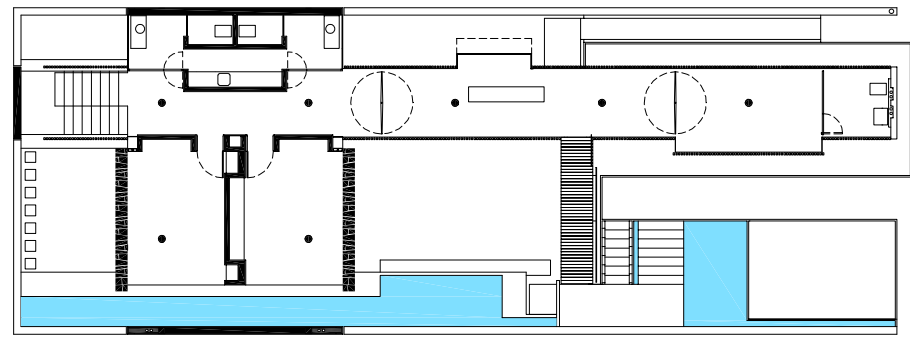
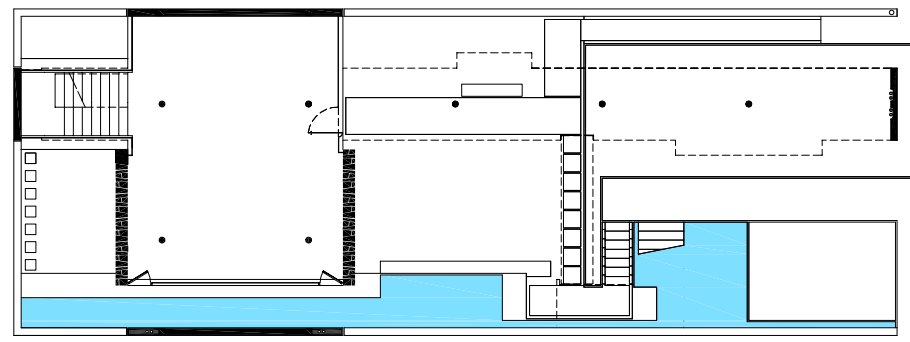



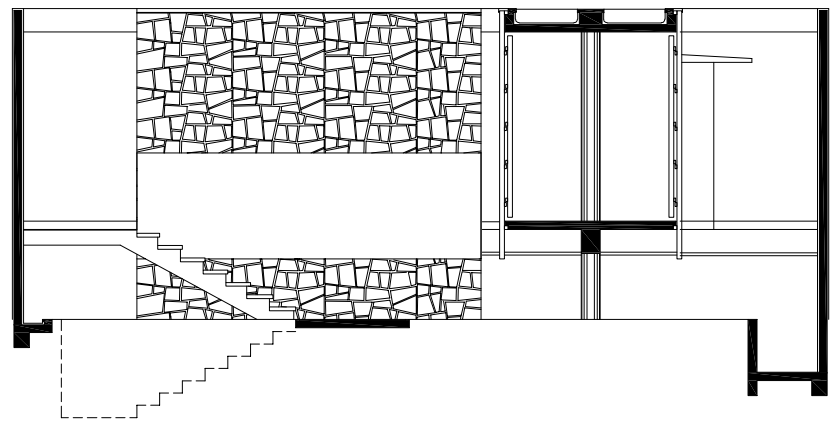



# DENTAL CLINIC

1998 Orlandia, SP

**ARCHITECTURE** Angelo Bucci, Fernando de Mello Franco, Marta Moreira, Milton Braga

**DESIGN TEAM** Keila Costa, Sandra Llovet Vilà



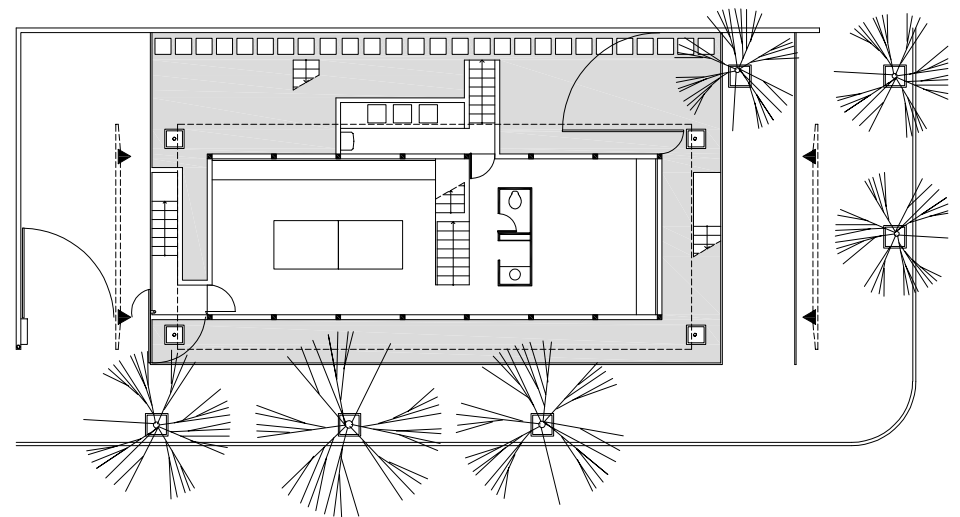
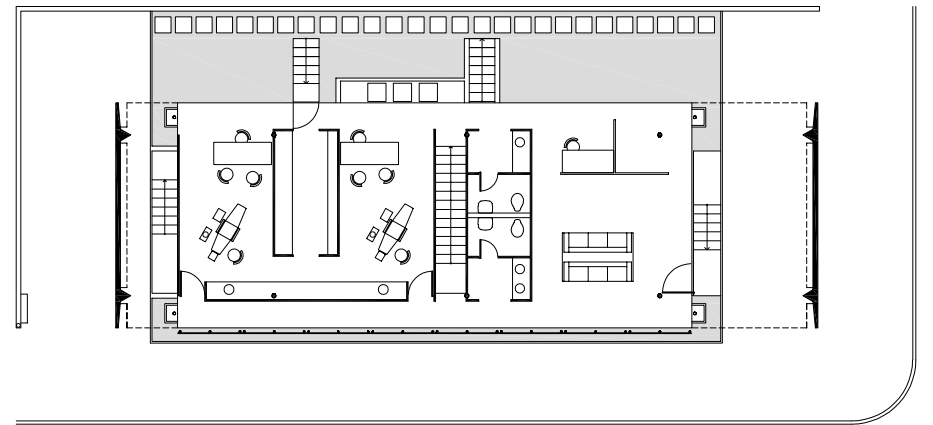



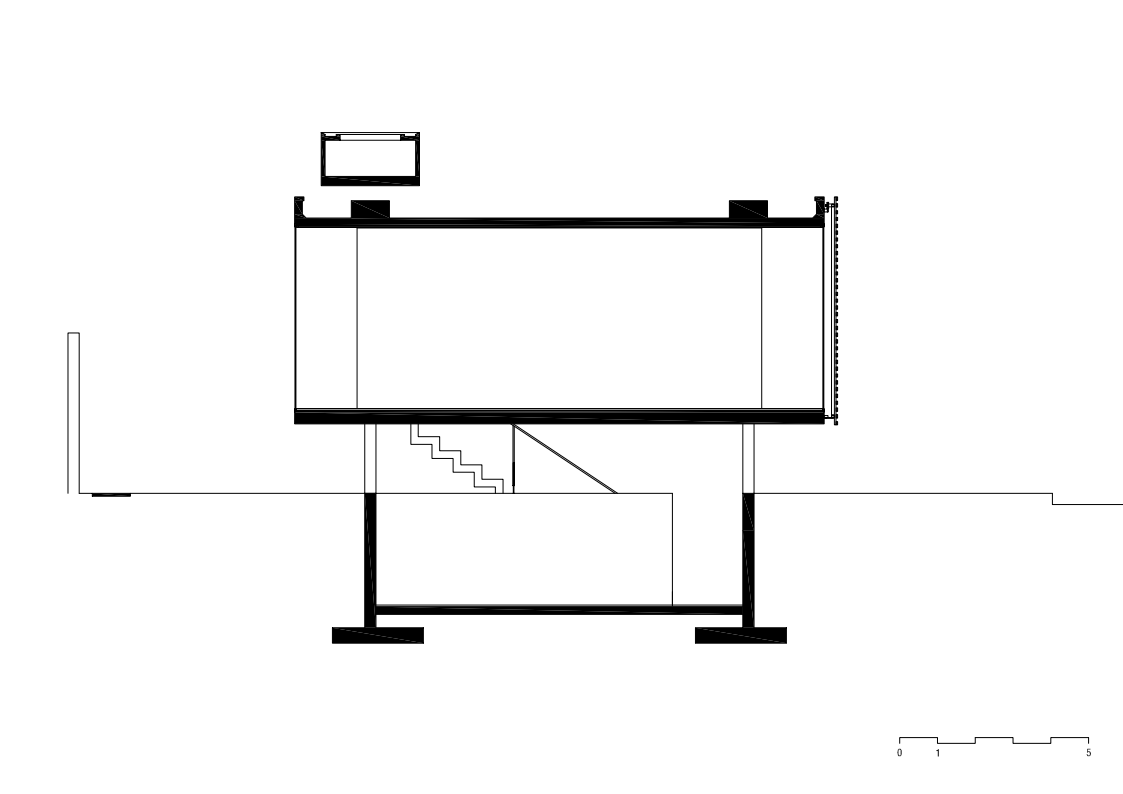



## HOUSE IN RIBEIRÃO PRETO

2001 Ribeirão Preto, SP

**ARCHITECTURE** Angelo Bucci, Fernando de Mello Franco, Marta Moreira, Milton Braga

**DESIGN TEAM** Anna Vilella, Eduardo Ferroni, Maju Herklotz, Eliana Mello

### AWARDS

Honourable Mention - V BIASP Architecture International Biennial of Sao Paulo 2003

Brazilian Institute of Architects Award - Best Built Residence 2002



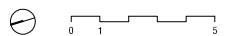
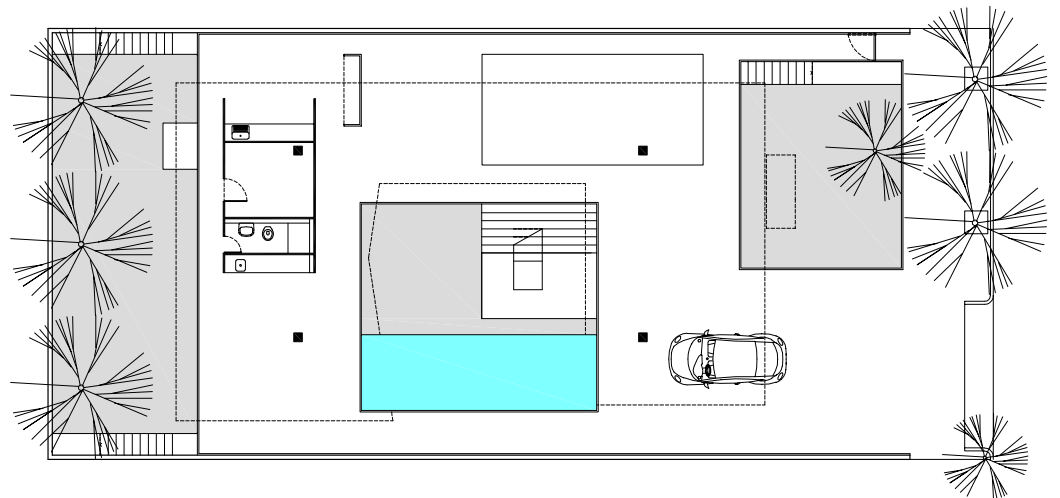
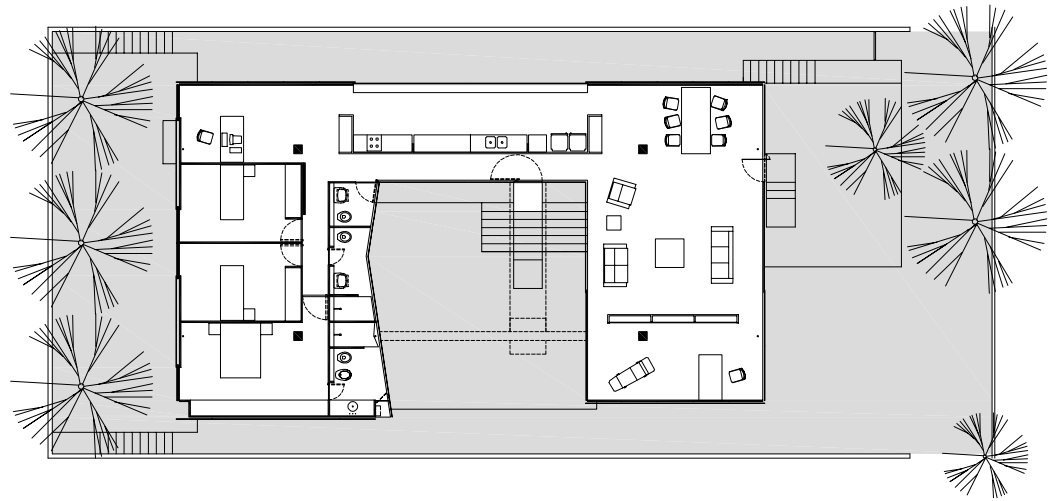
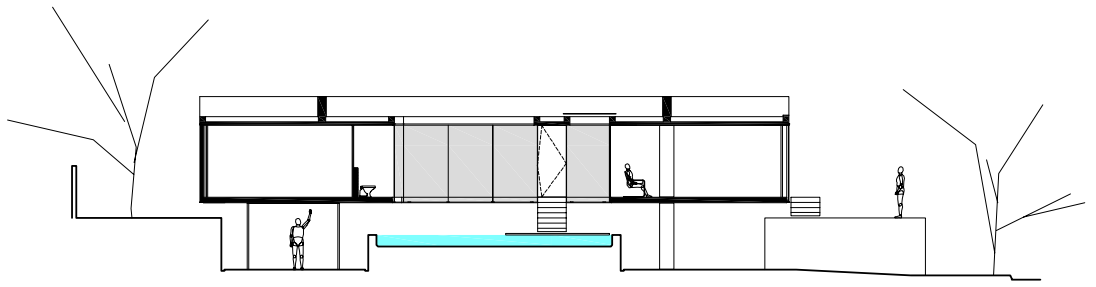





# HOUSE IN ALDEIA DA SERRA

2002 Aldeia da Serra, SP

**ARCHITECTURE** Angelo Bucci, Fernando de Mello Franco, Marta Moreira, Milton Braga

**DESIGN TEAM** Anna Vilella, Eduardo Ferroni, Maju Herklotz, André Drummond





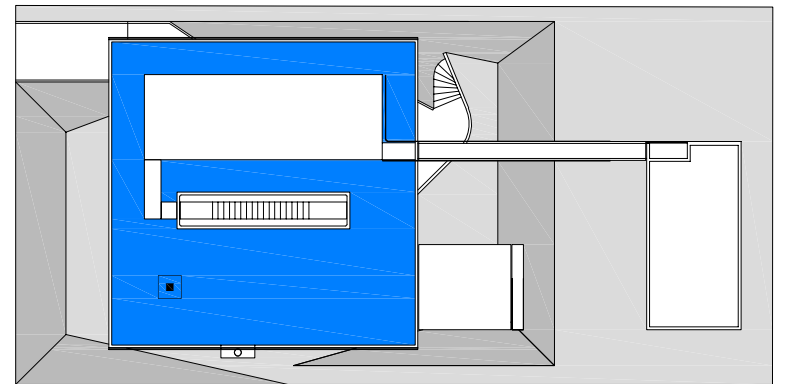
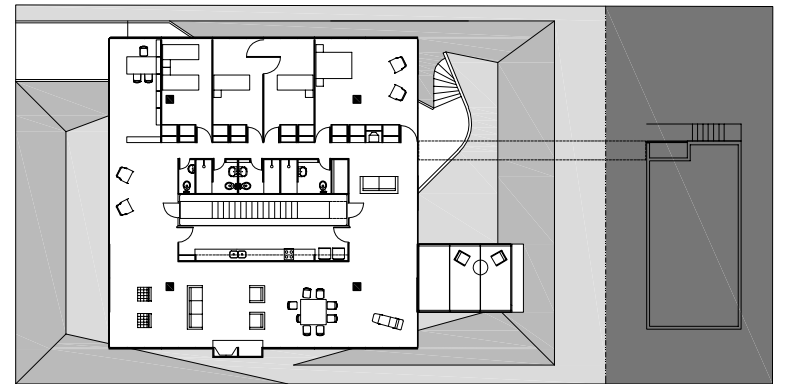
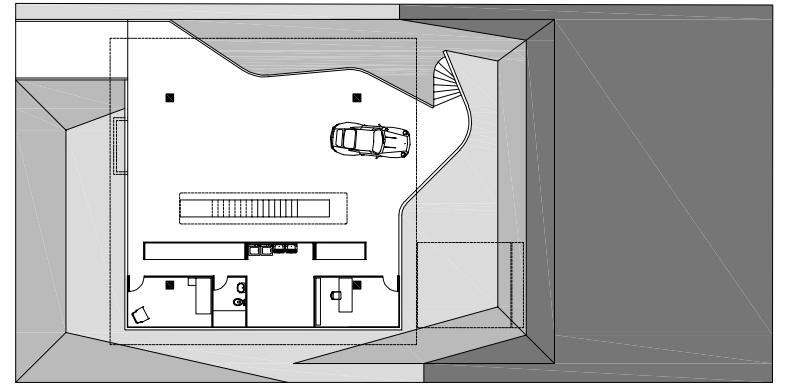



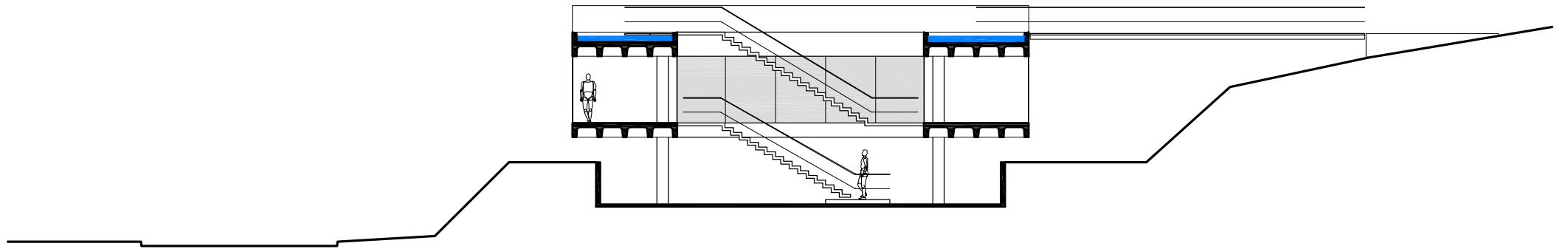



# FDE SCHOOL AT JARDIM ATALIBA LEONEL

2003-2004 São Paulo, SP

**ARCHITECTURE** Angelo Bucci, Alvaro Puntoni

**DESIGN TEAM** Maria Isabel Imbronito, Ciro Miguel, Juliana Braga, Carolina Gimenez, Tobias Xavier, Omar Dalank





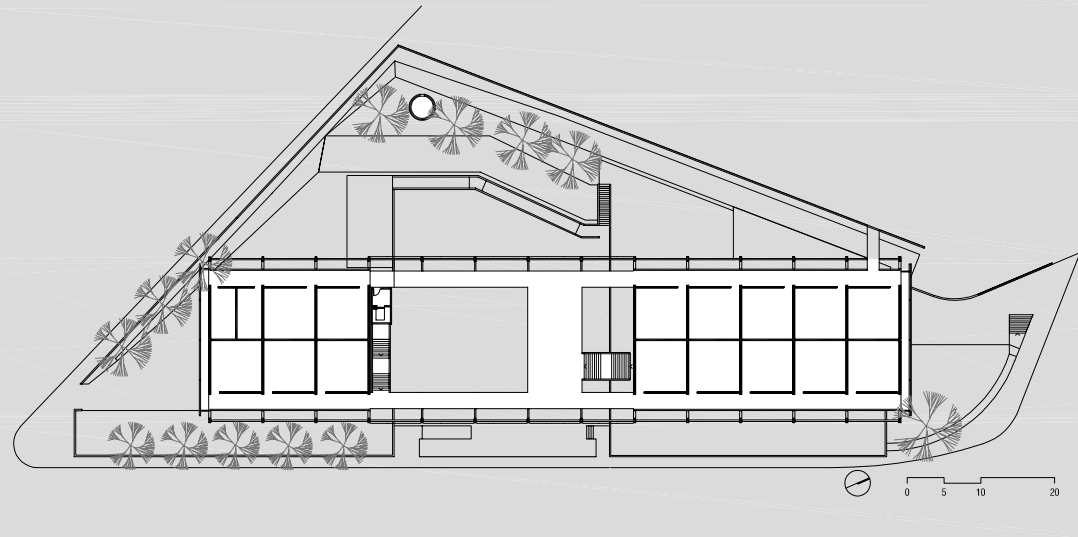
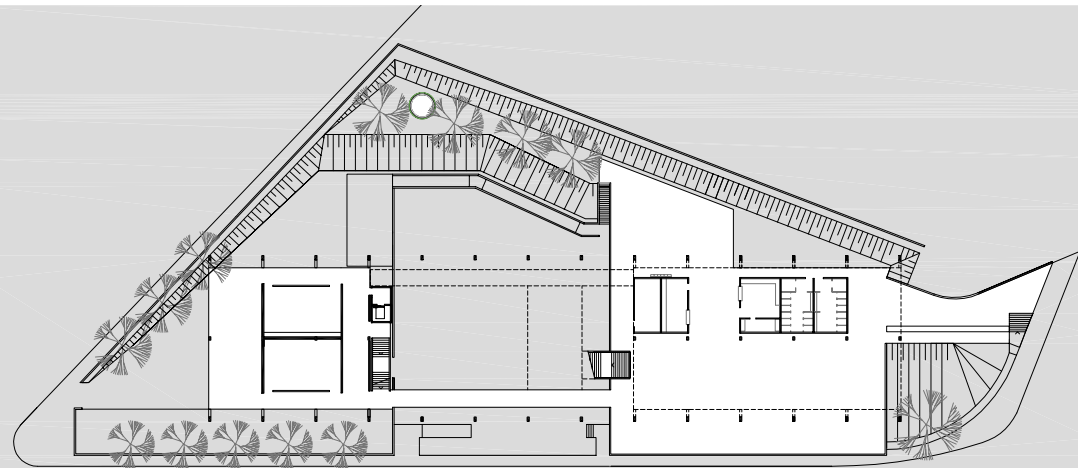
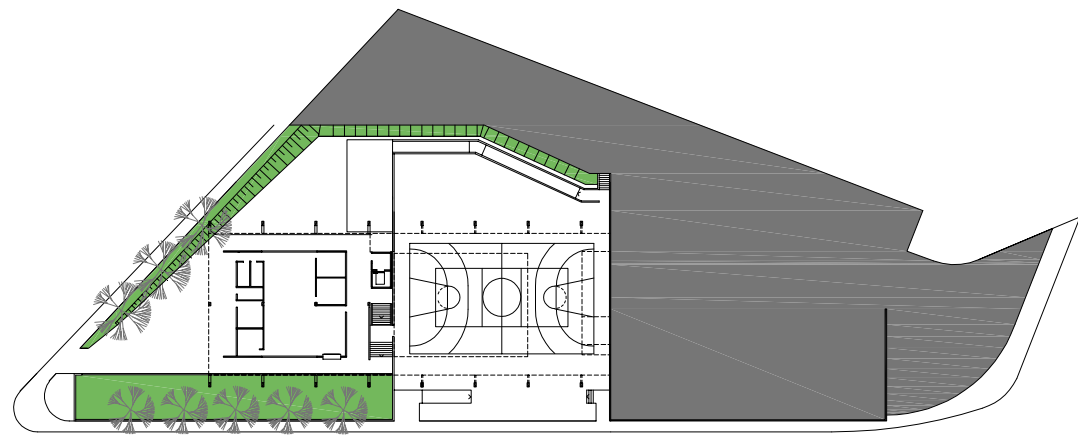

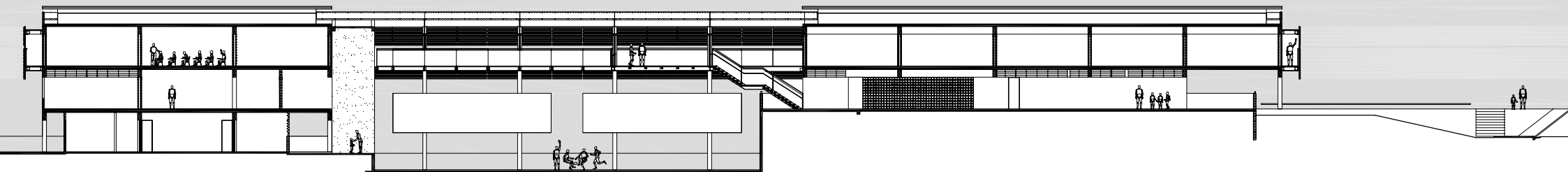



# HOUSE IN CARAPICUÍBA

2003 Carapicuíba, SP

**ARCHITECTURE** Angelo Bucci, Alvaro Puntoni

**DESIGN TEAM** Ciro Miguel, Juliana Braga, Fernando Bizarri





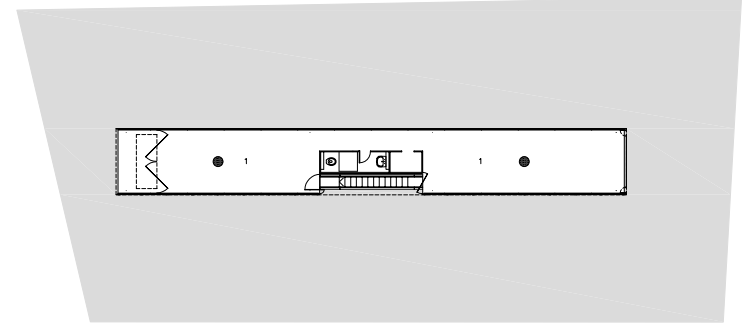
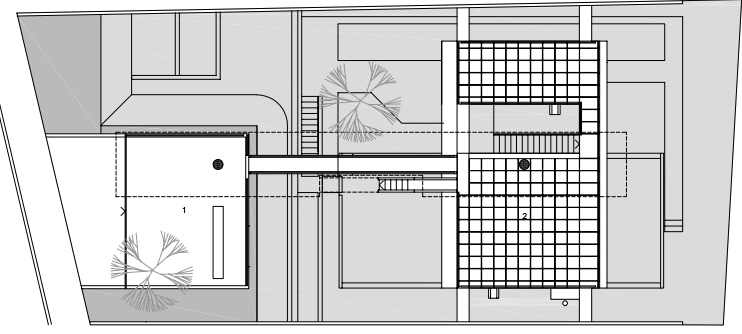
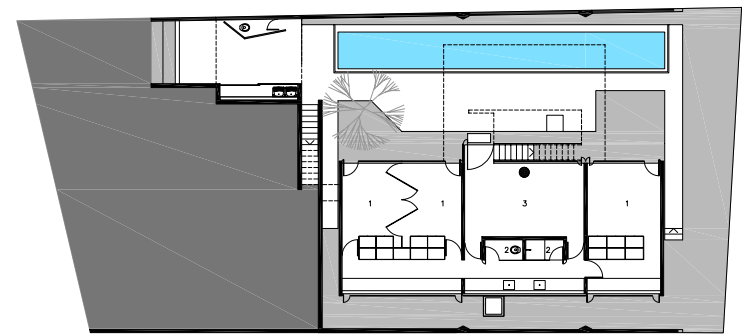



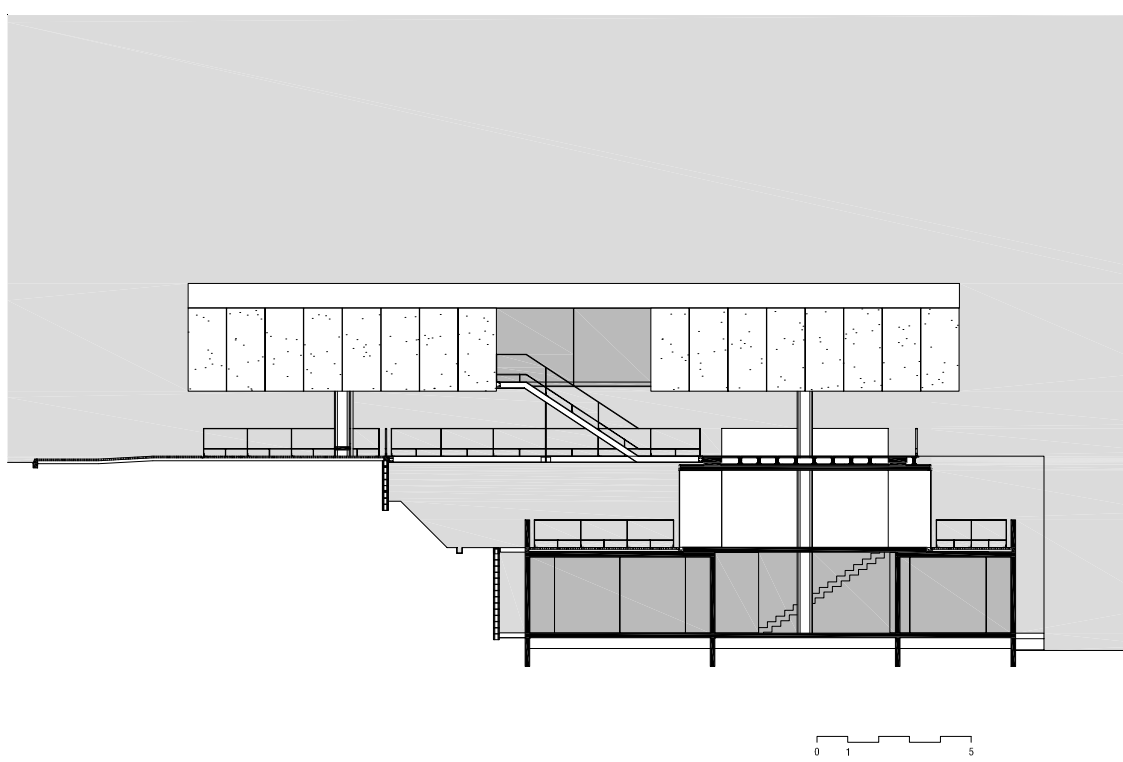



# HOUSE IN SANTA TERESA

2004 Rio de Janeiro, RJ

**ARCHITECTURE** Angelo Bucci

**DESIGN TEAM** Ciro Miguel, Juliana Braga,  
Maria Isabel Imbronito, Susana Jeque, Tatiana Ozzetti

## AWARDS

O Melhor da Arquitetura 2008 - Arquitetura e Construção Magazine

Honourable Mention - VII BIASP Architecture International Biennial of Sao Paulo 2007

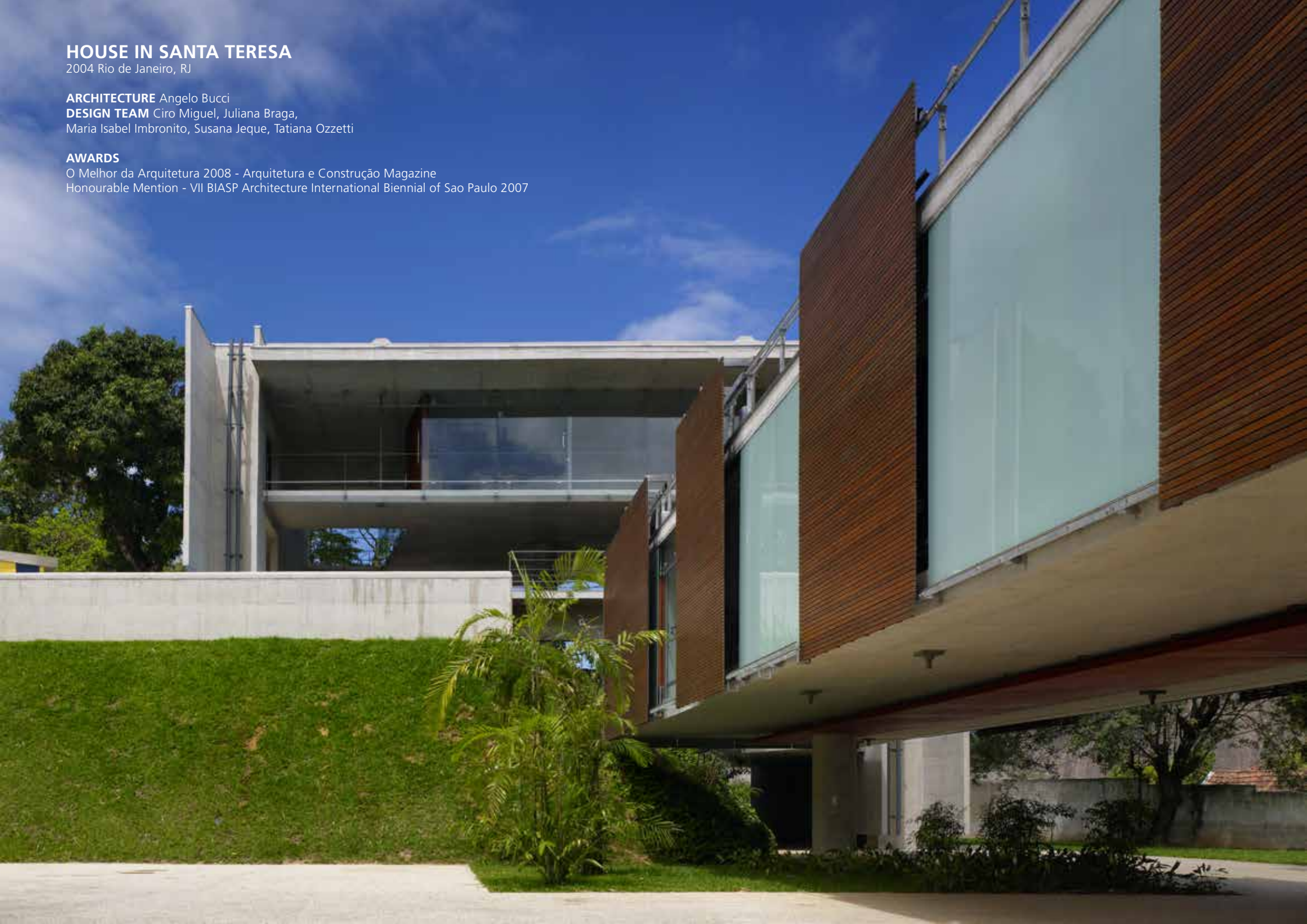



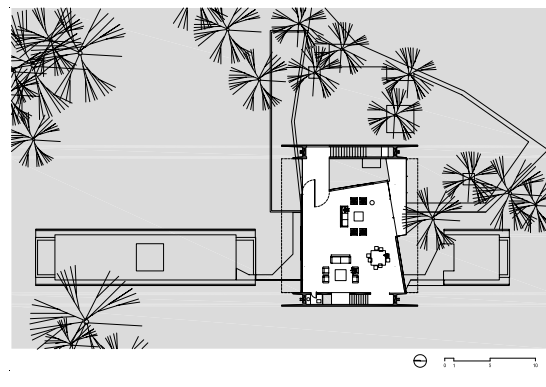
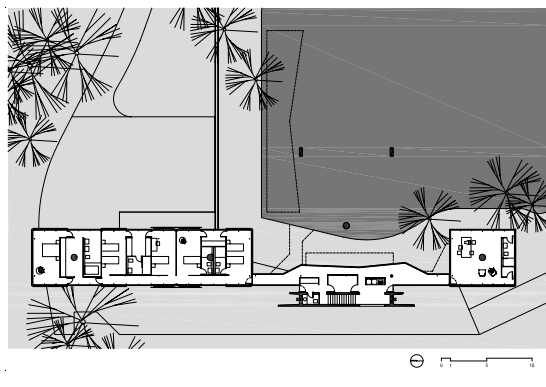
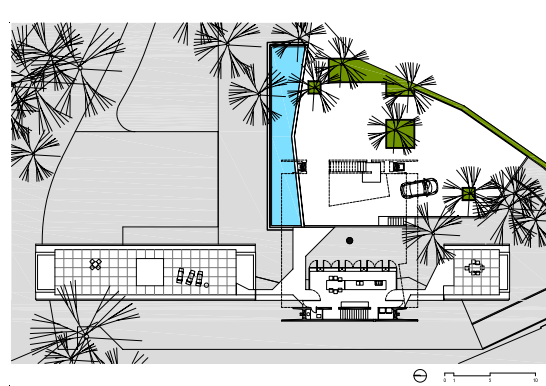
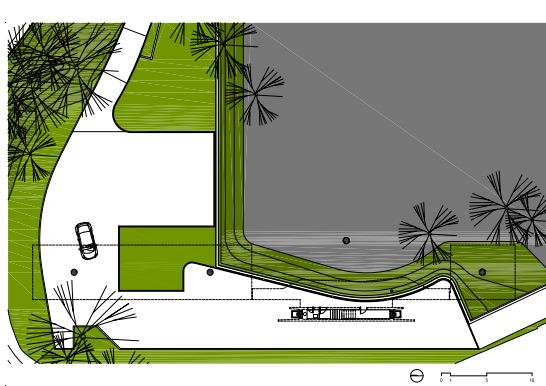



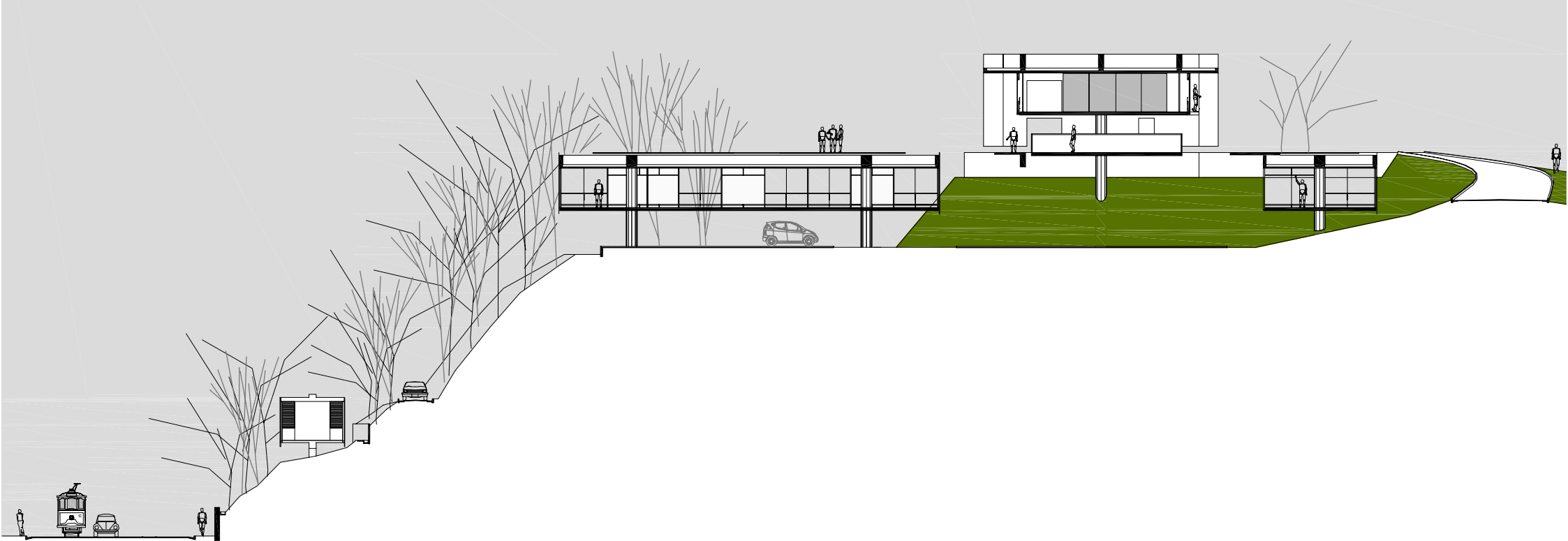



# HOUSE IN UBATUBA

2005-2010 Ubatuba, SP

**ARCHITECTURE** Angelo Bucci

**DESIGN TEAM** Ciro Miguel, Juliana Braga, João Paulo Meirelles de Faria, Flávia Parodi Costa, Tatiana Ozzetti, Lucas Nobre, Nilton Suenaga

**AWARDS** 'Arquitetura e Construção' awards 2010  
Engineering Talent Awards 2012





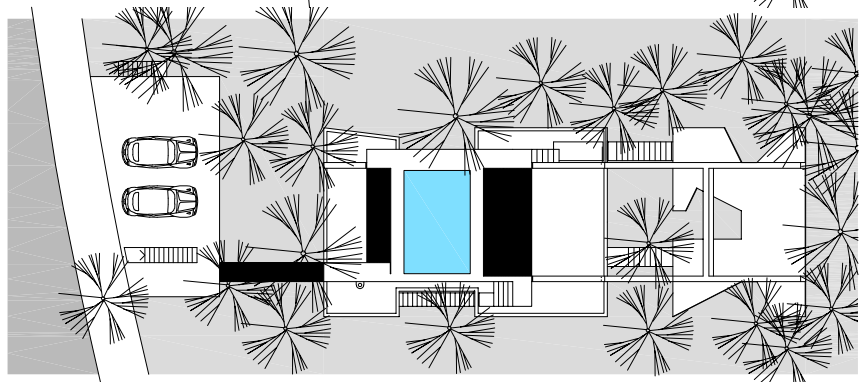
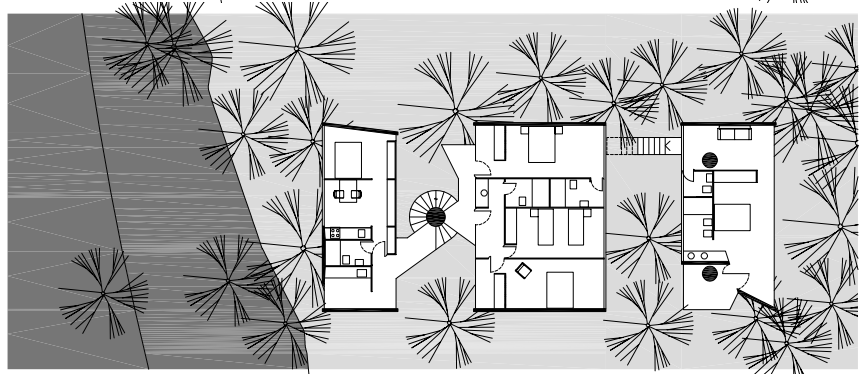
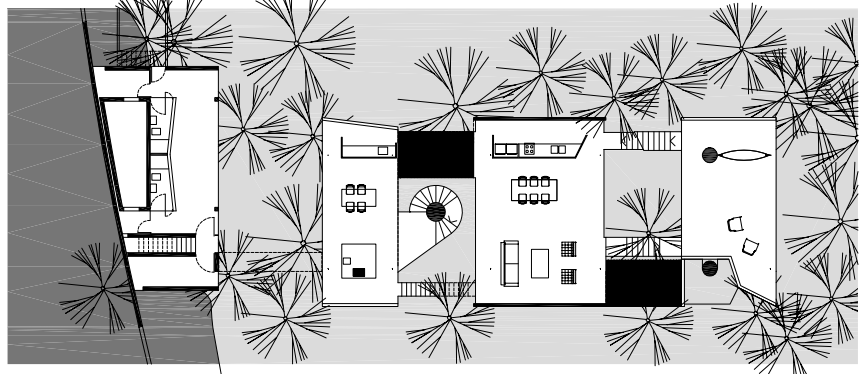
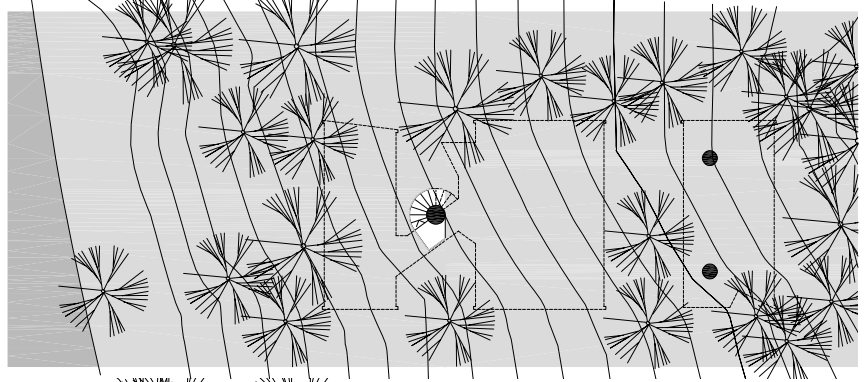



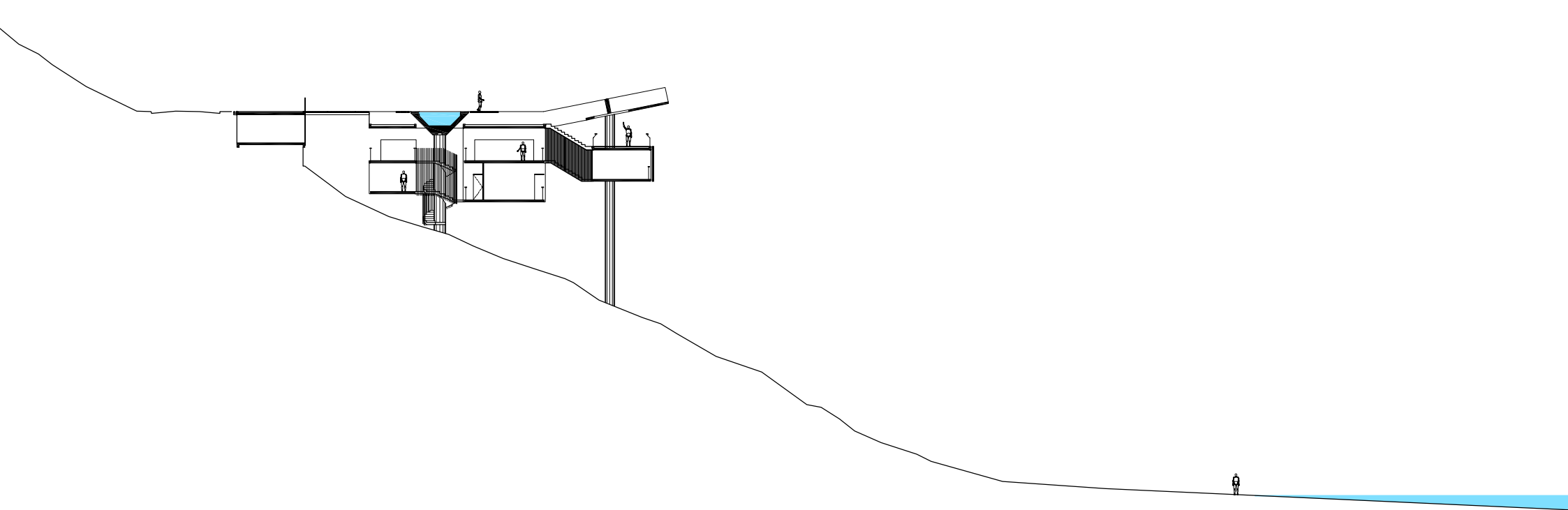



## APARTMENT BUILDING IN LUGANO

2009-2010 Lugano, Switzerland

**ARCHITECTURE** Angelo Bucci, João Paulo Meirelles de Faria, Nicola Baserga, Christian Mozzetti

**DESIGN TEAM** Tatiana Ozzetti, Eric Ennser, Ladislao Ricci, Valeria Didone

**STRUCTURE** Andrea Pedrazzini, Eugenio Pedrazzini





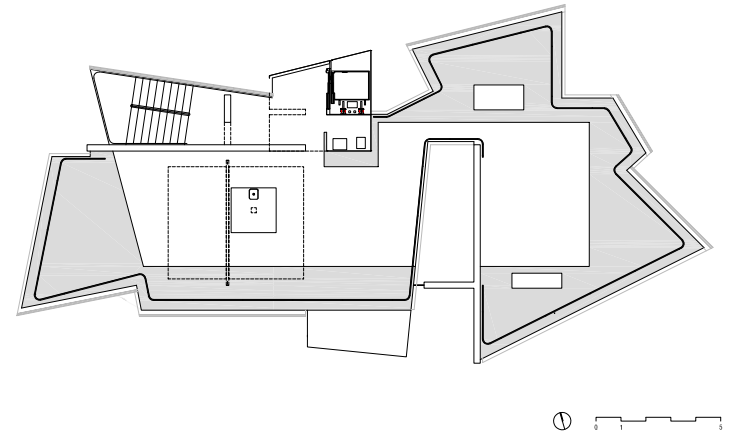
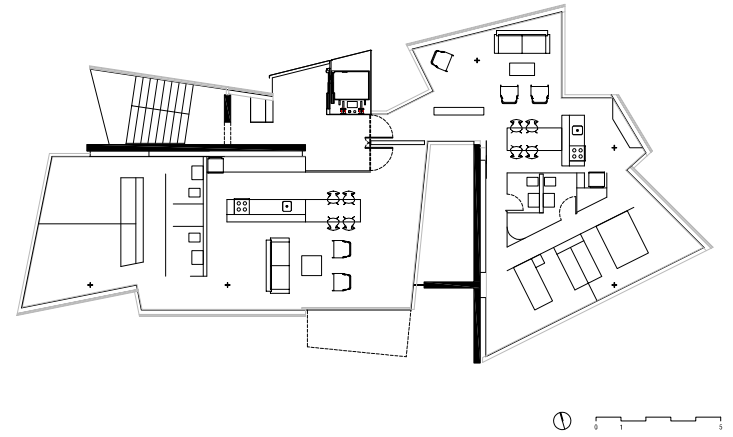
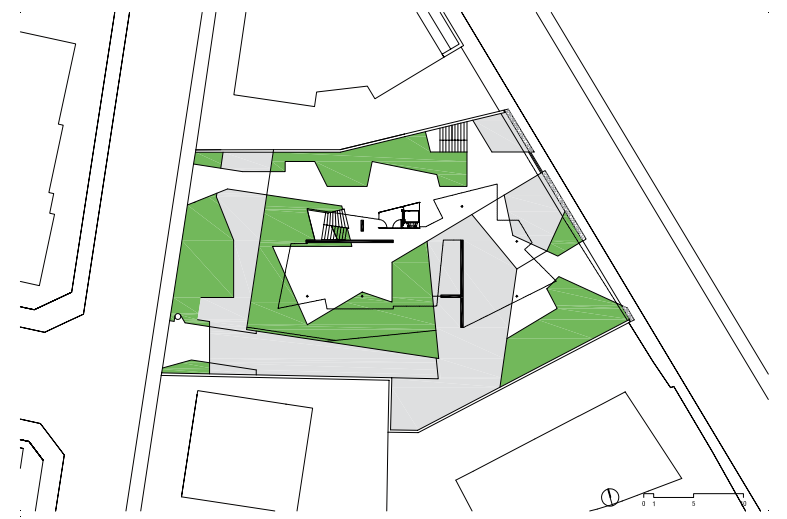







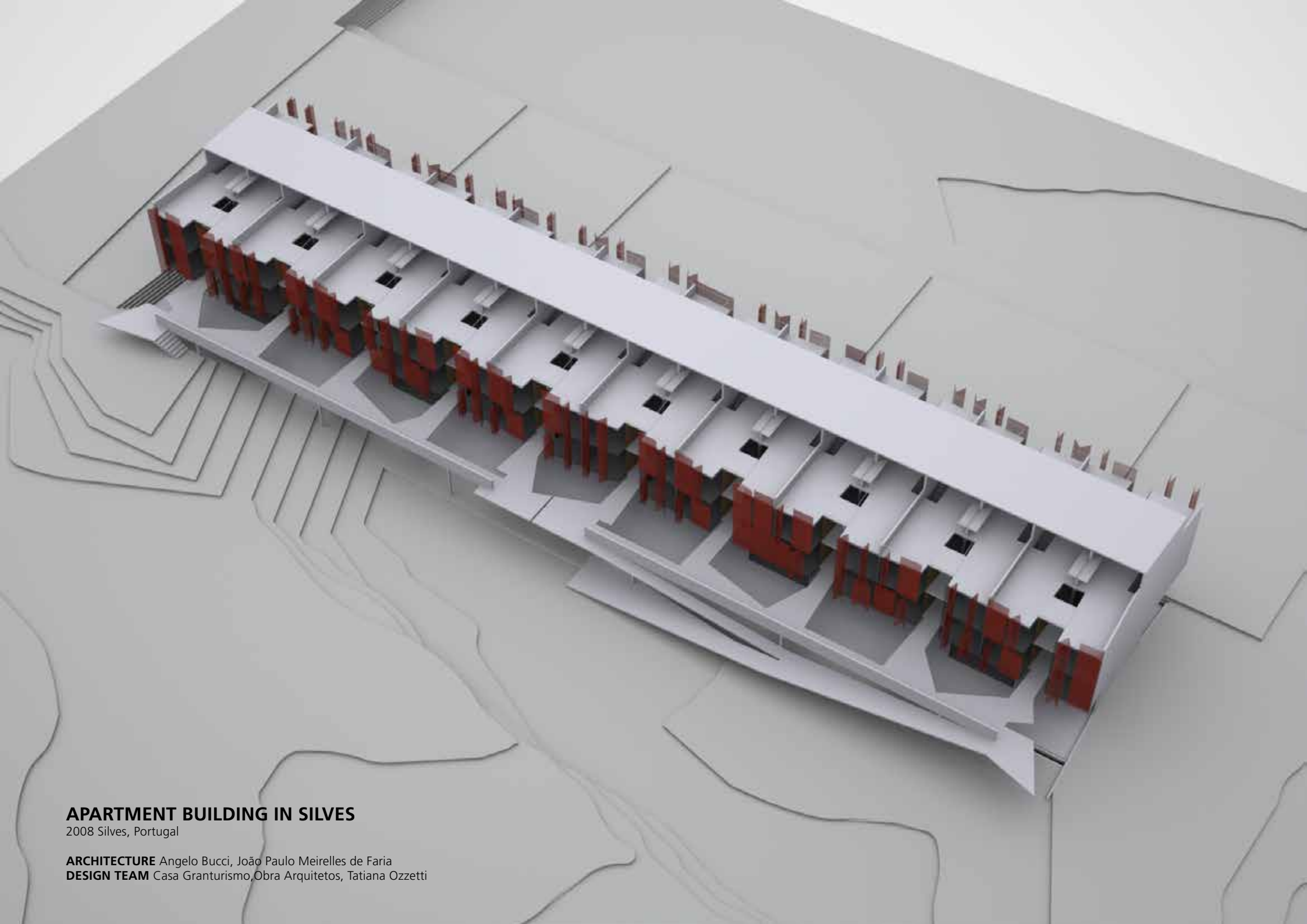

## APARTMENT BUILDING IN SILVES

2008 Silves, Portugal

**ARCHITECTURE** Angelo Bucci, João Paulo Meirelles de Faria

**DESIGN TEAM** Casa Granturismo, Obra Arquitetos, Tatiana Ozzetti



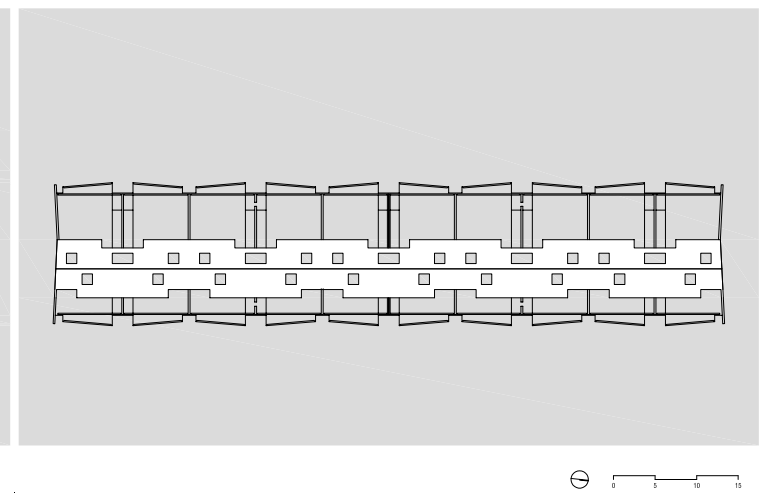
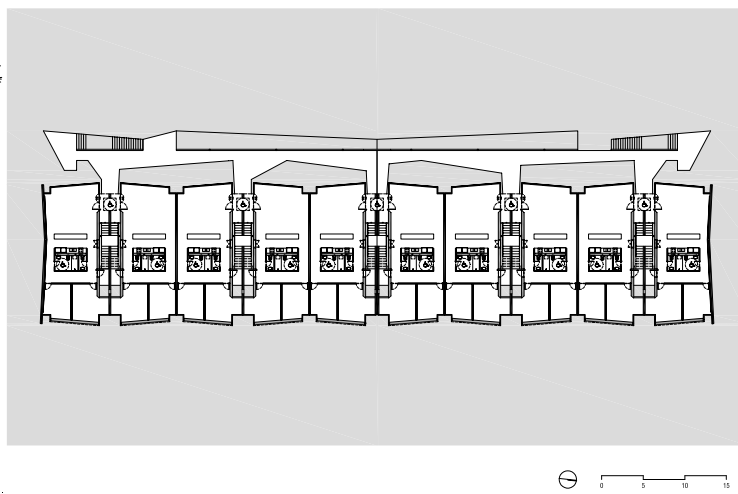
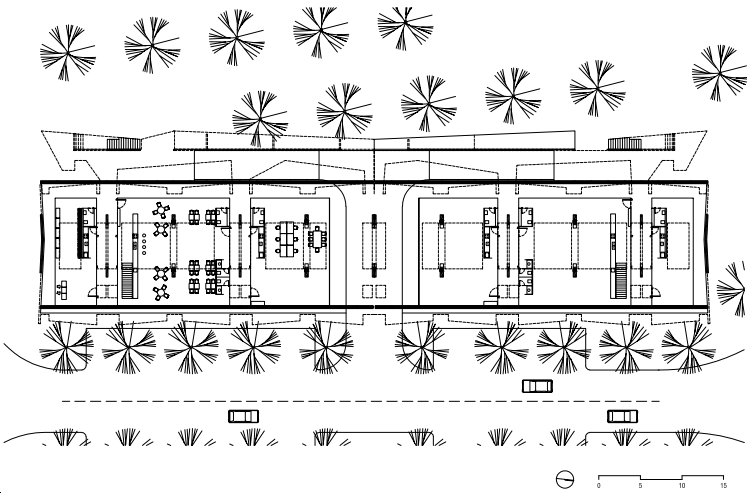



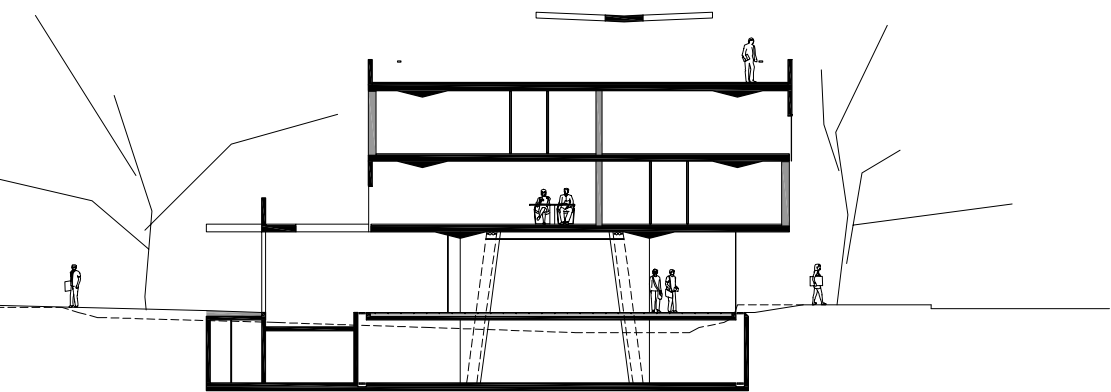

0 1 5





# WEEKEND HOUSE AT SÃO PAULO

2010-2012 São Paulo, SP

**ARCHITECTURE** Angelo Bucci

**DESIGN TEAM** Ciro Miguel, Eric Enns, João Paulo Meirelles de Faria, Juliana Braga, Tatiana Ozzetti



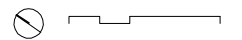
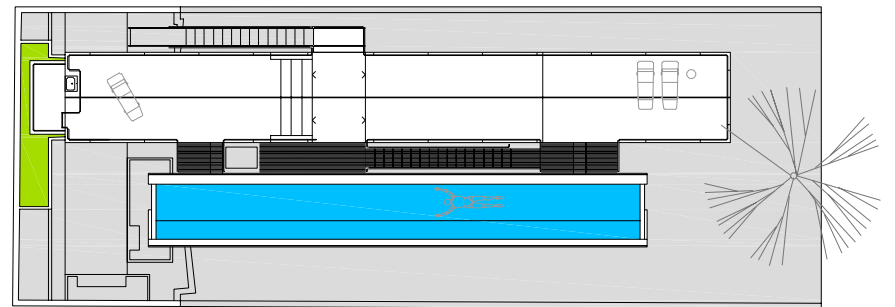
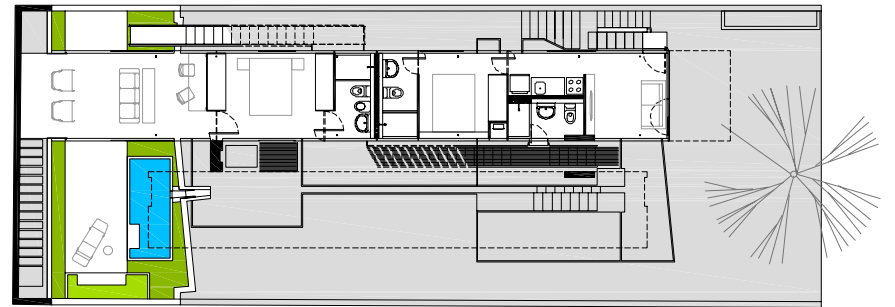
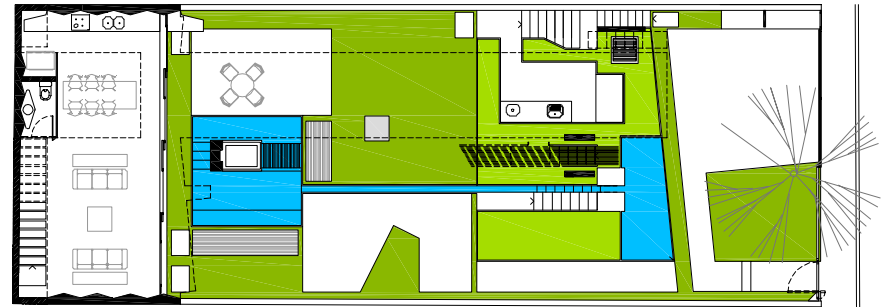



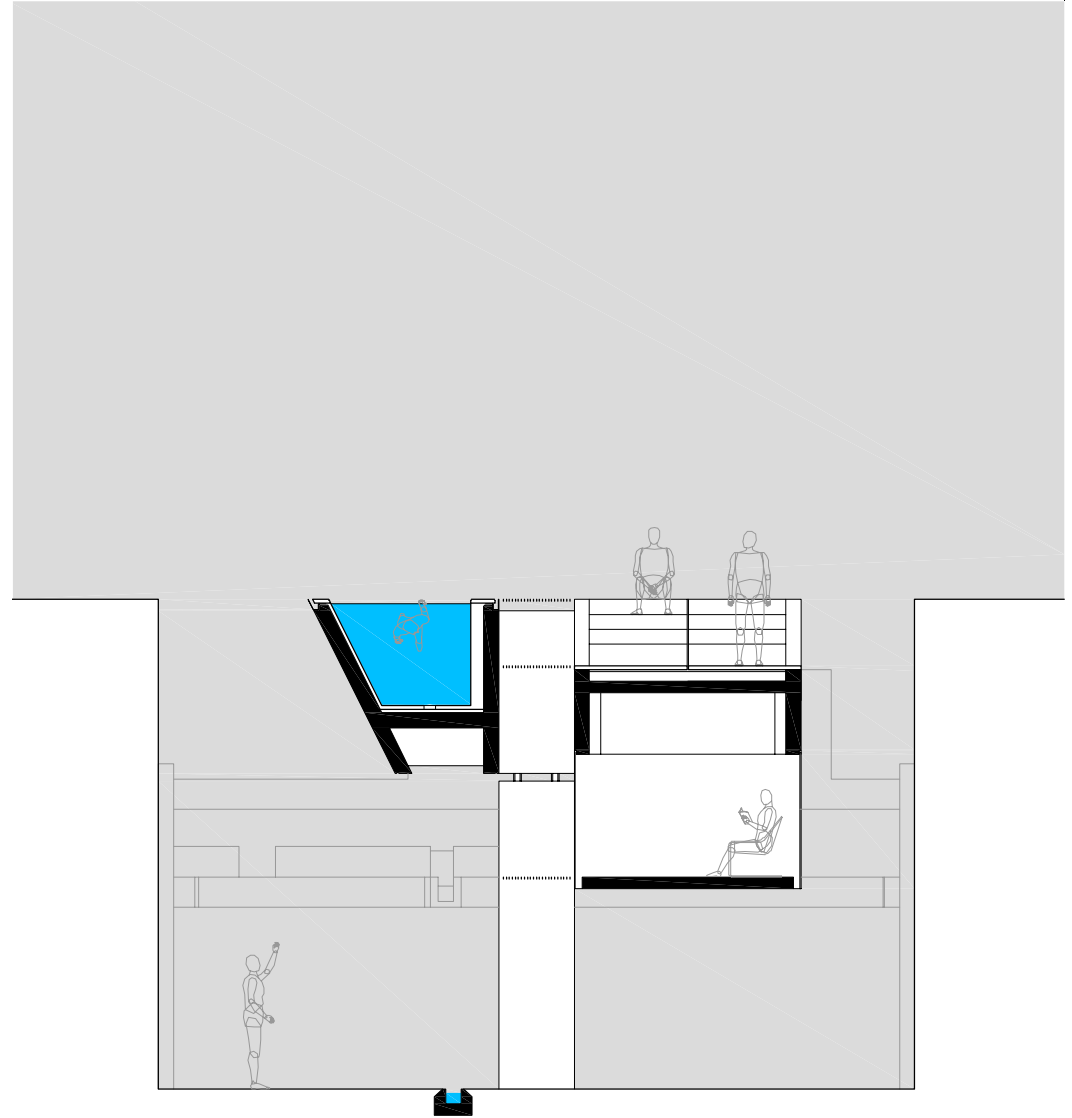

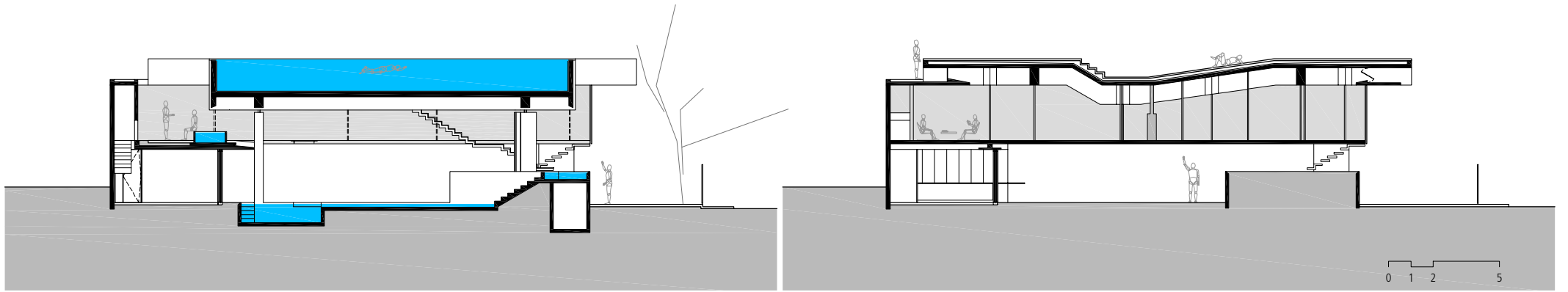



# HOUSE IN ITAIPAVA

2010-2012 Itaipava, RJ (under construction)

**ARCHITECTURE** Angelo Bucci

**DESIGN TEAM** Ciro Miguel, Eric Ennsner, Juliana Braga, Nilton Suenaga, Tatiana Ozzetti



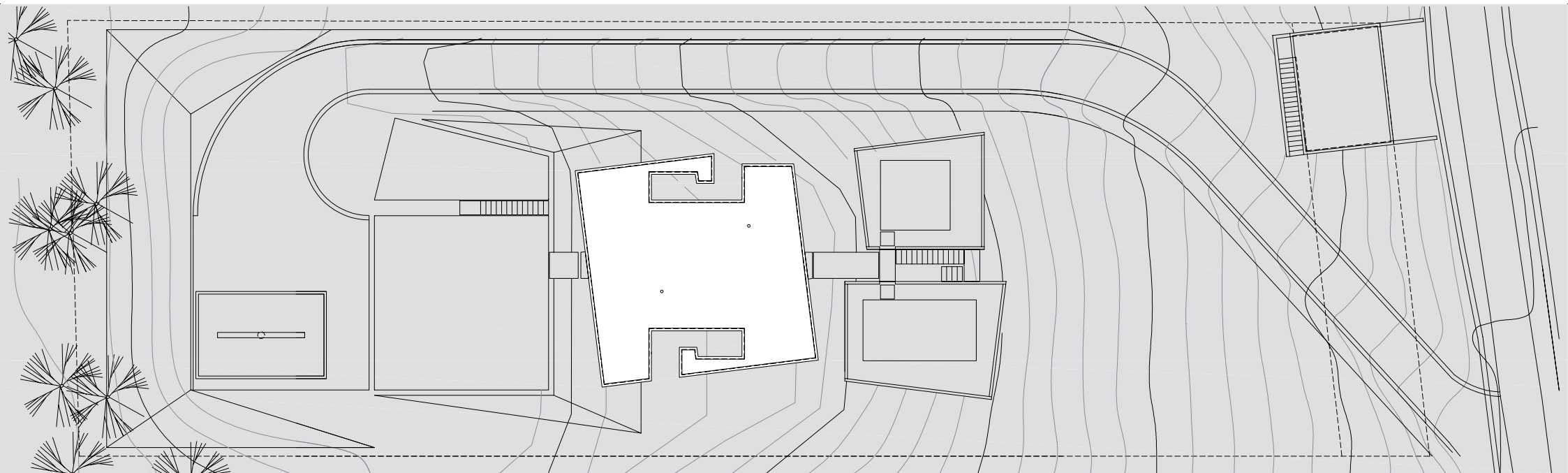



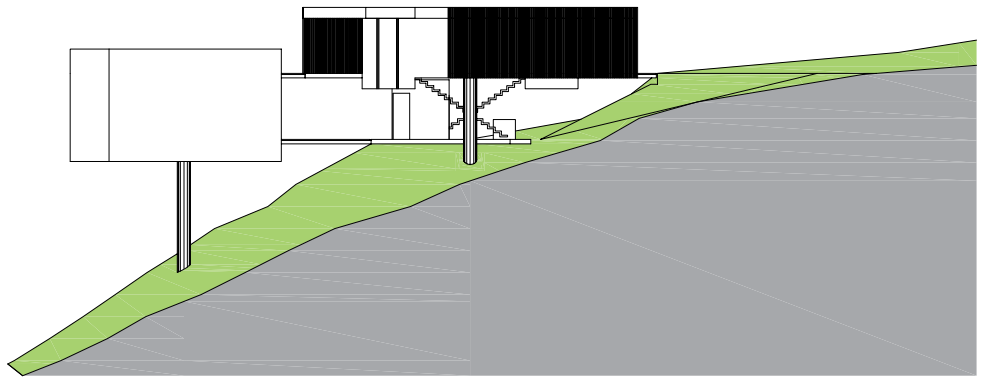
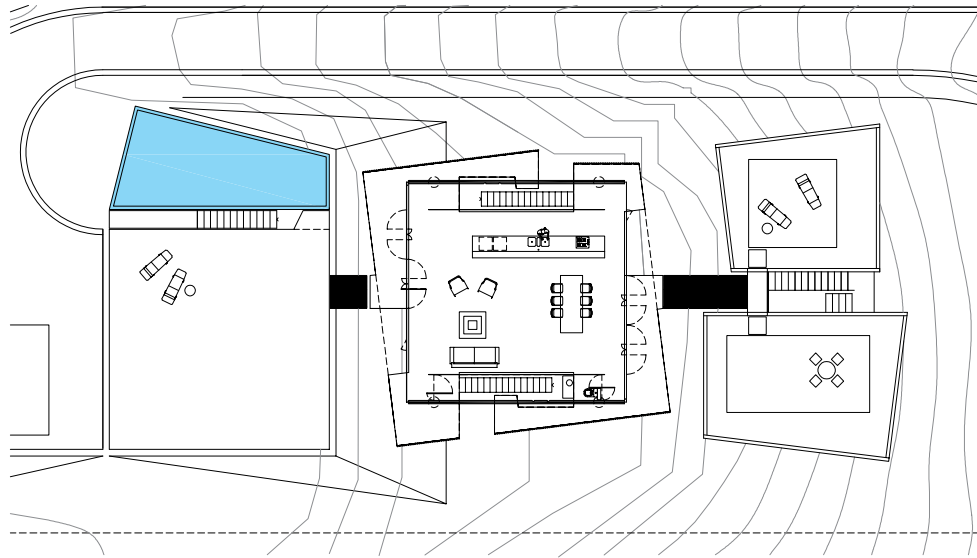
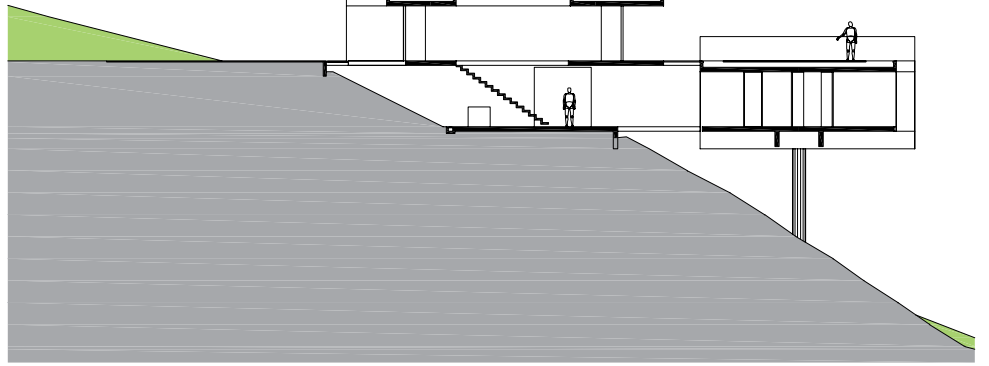
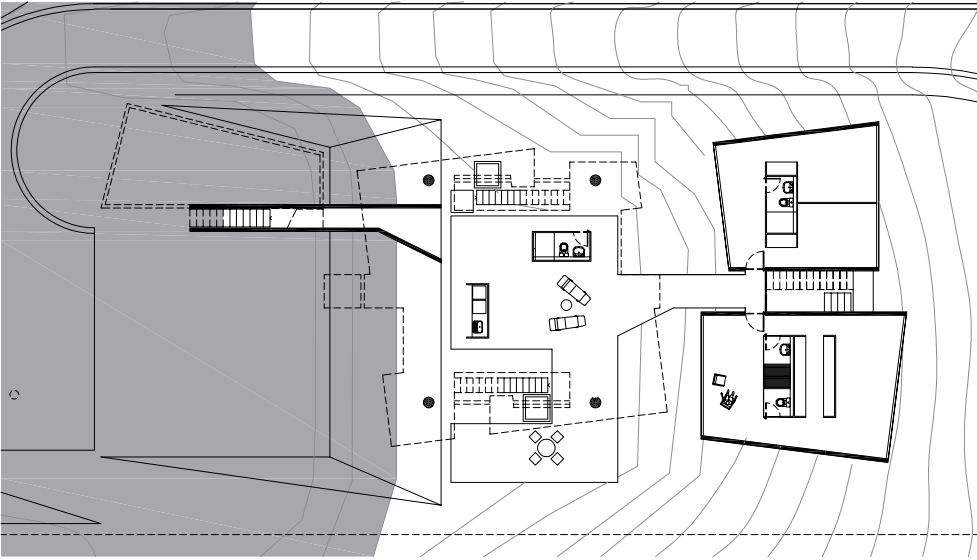

0 1 2 5 [m]

0 1 2 5 [m]

# HOUSE AND STUDIO IN ORLÂNDIA

2007-2012 Orllândia, SP

**ARCHITECTURE** Angelo Bucci

**DESIGN TEAM** Ciro Miguel, Eric Ennsner, João Paulo Meirelles de Faria, Juliana Braga, Nilton Suenaga, Tatiana Ozzetti, Victor Próspero

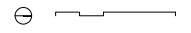
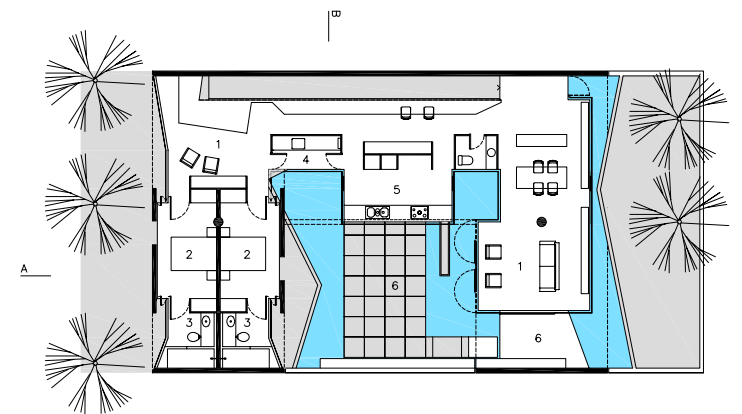
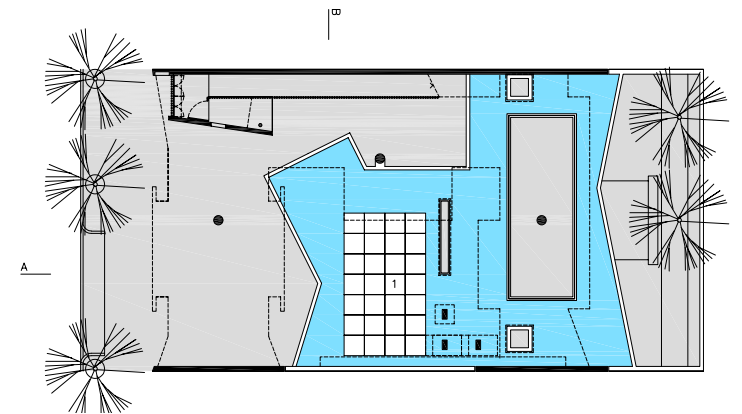
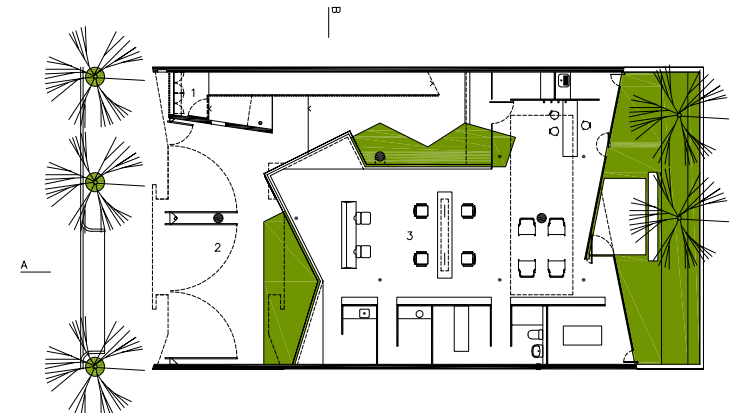
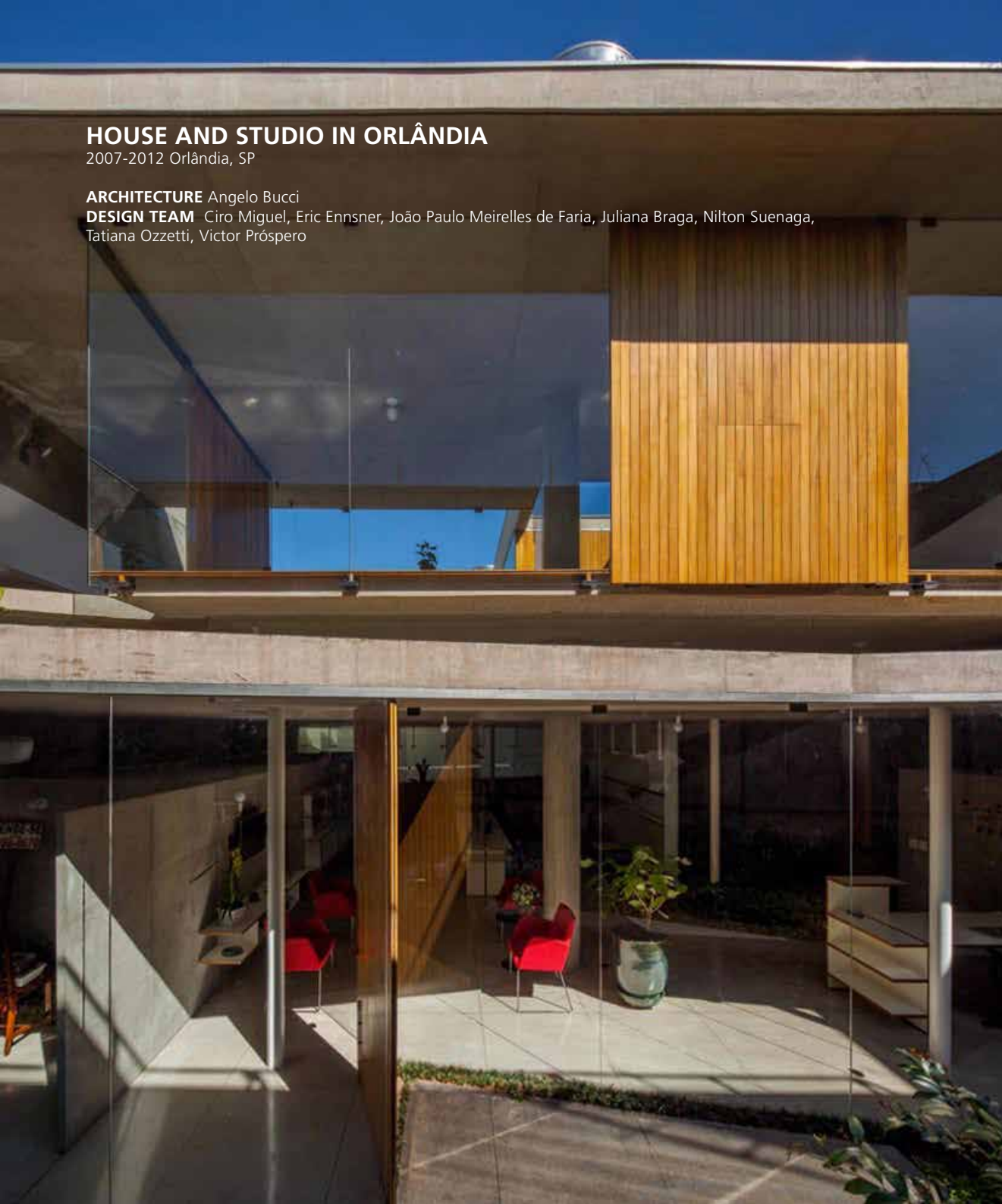



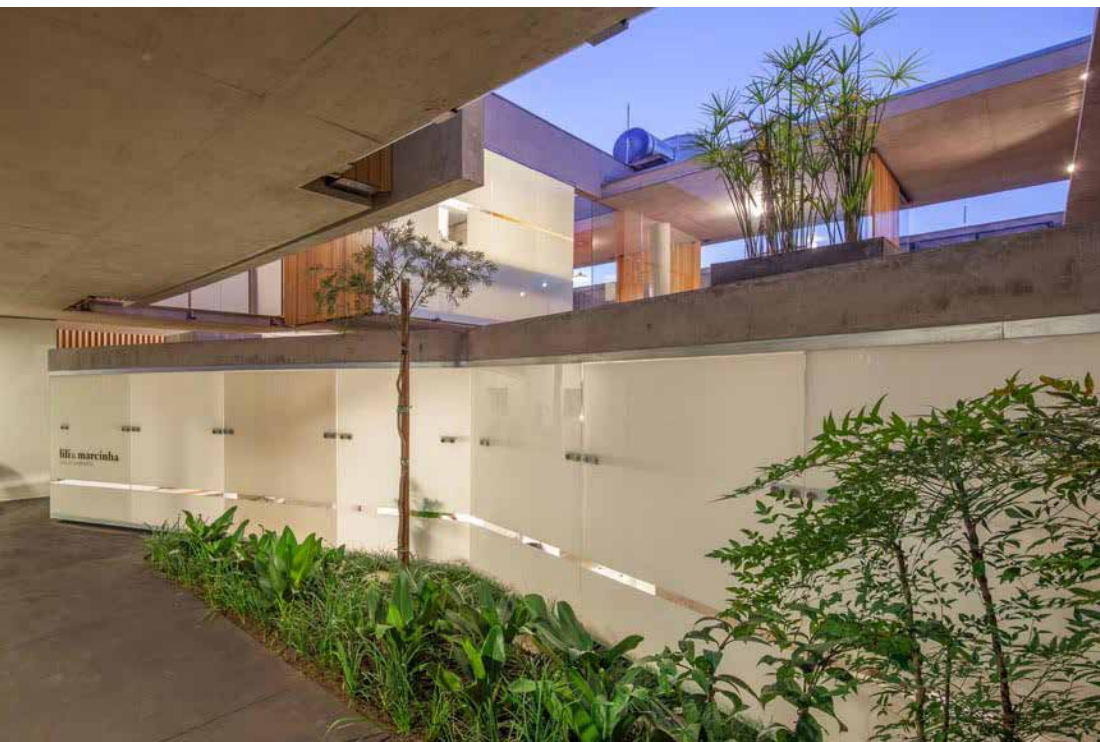

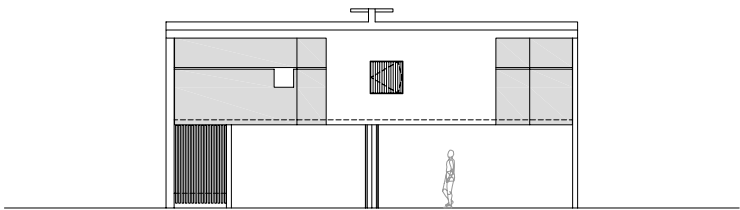
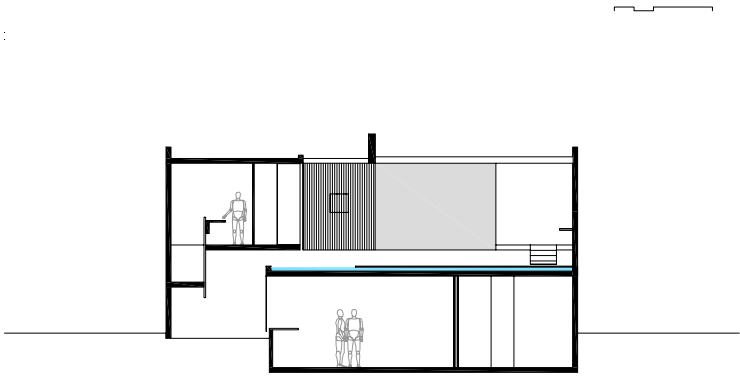
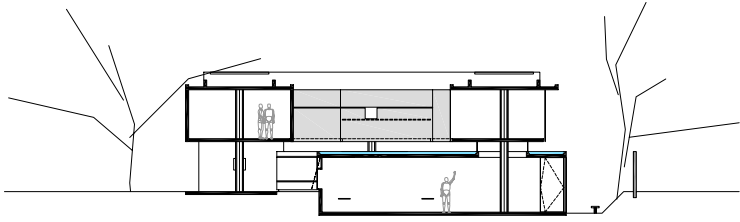



# HOUSE RENOVATION IN ORLÂNDIA

2007-2010 Orlandia, SP

**ARCHITECTURE** Angelo Bucci

**DESIGN TEAM** Ciro Miguel, Eric Ennsner, João Paulo Meirelles de Faria, Juliana Braga, Nilton Suenaga, Tatiana Ozzetti

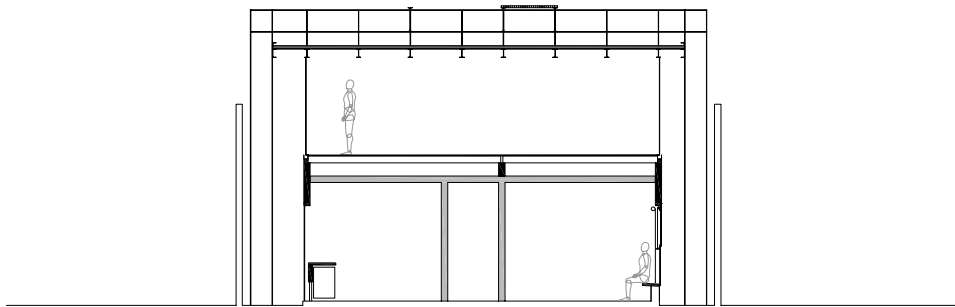
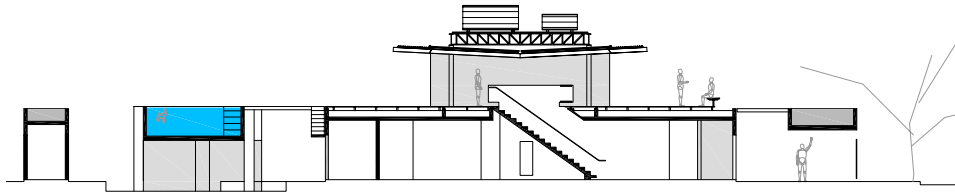

0 1 2 3









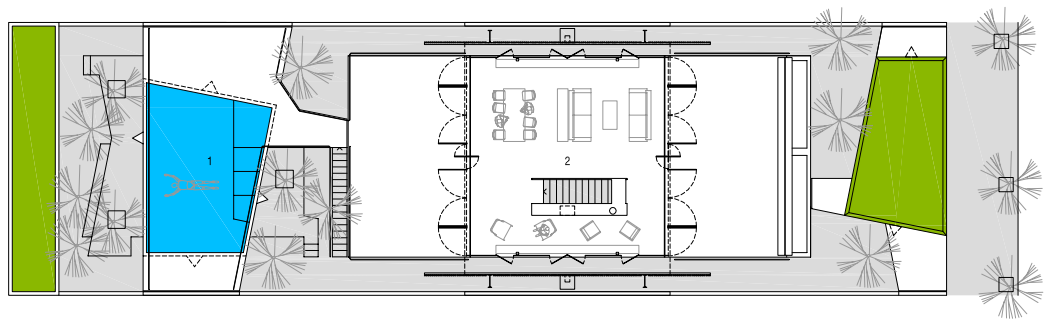
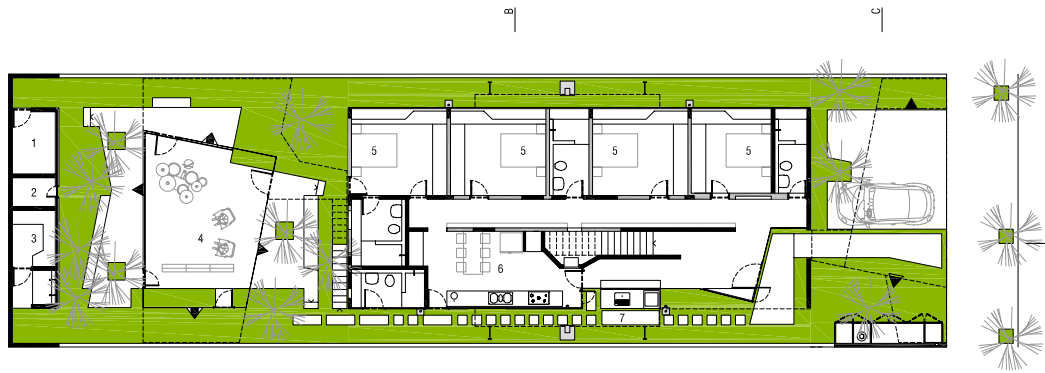

# PUC-RIO MEDIATHEQUE [COMPETITION - FIRST PLACE]

2006 Rio de Janeiro, RJ

**ARCHITECTURE** Angelo Bucci, Ciro Miguel, João Paulo Meirelles de Faria, Juliana Braga

**AWARDS** Holcim Sustainable Architecture Award - Silver category

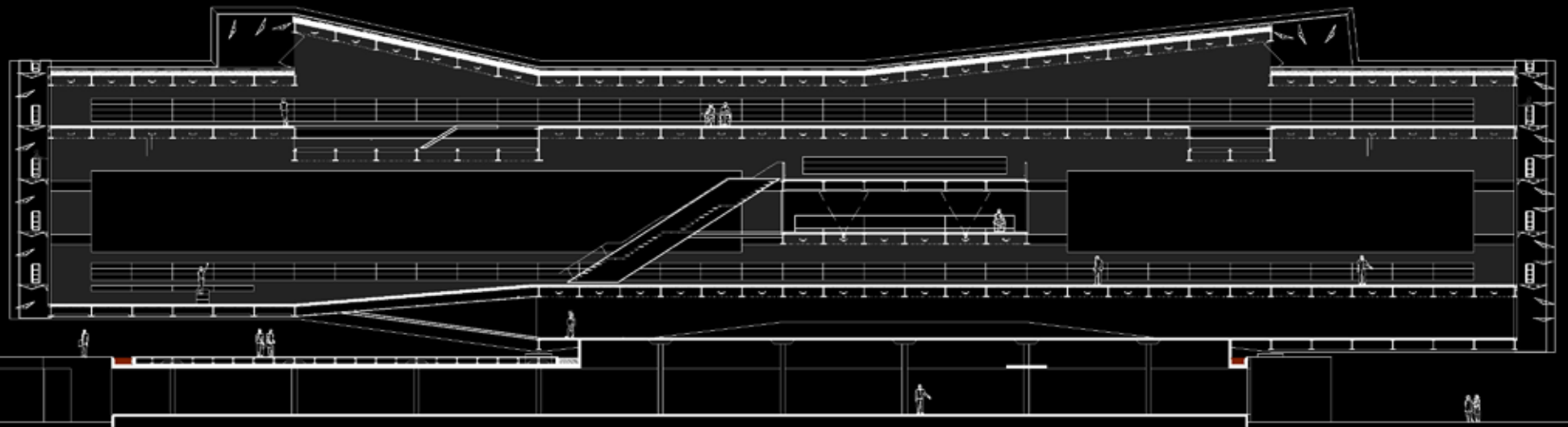
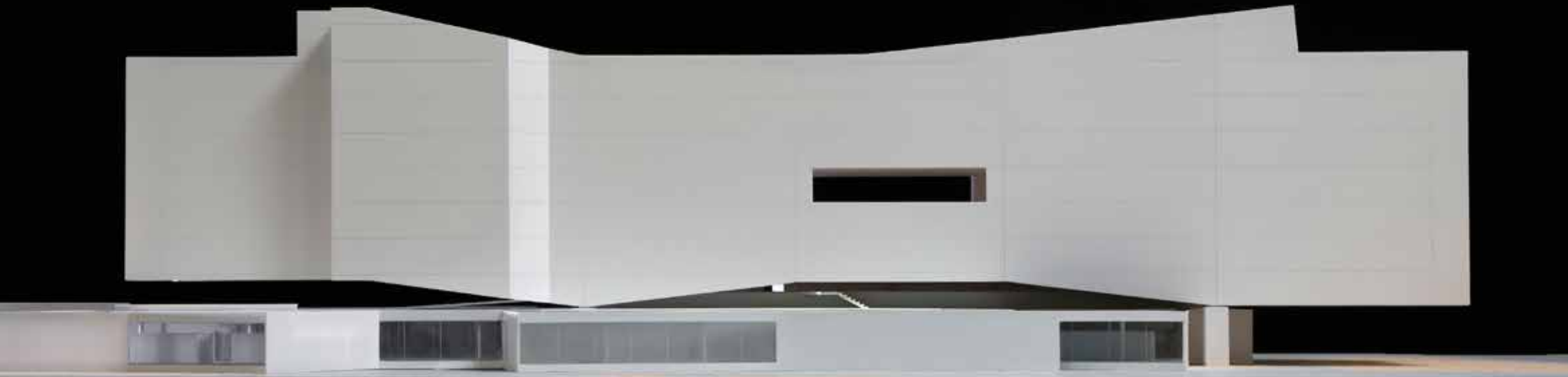



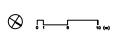
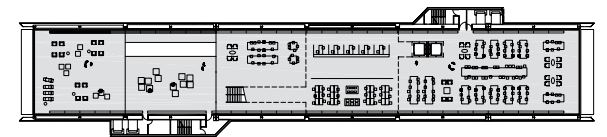
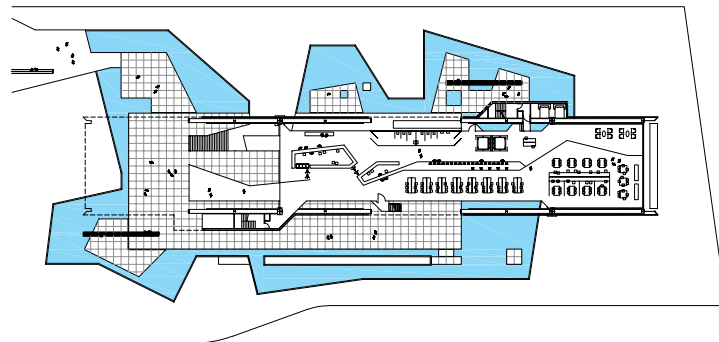
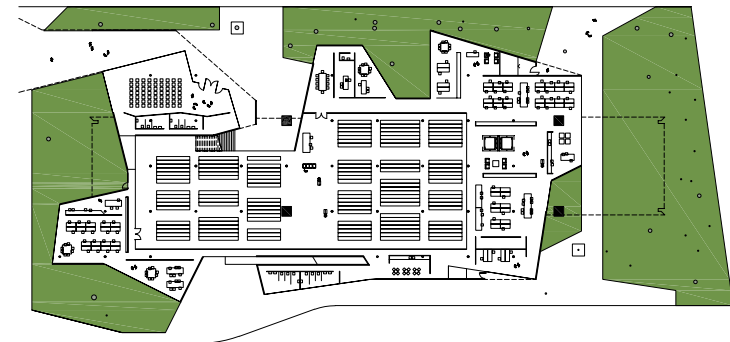

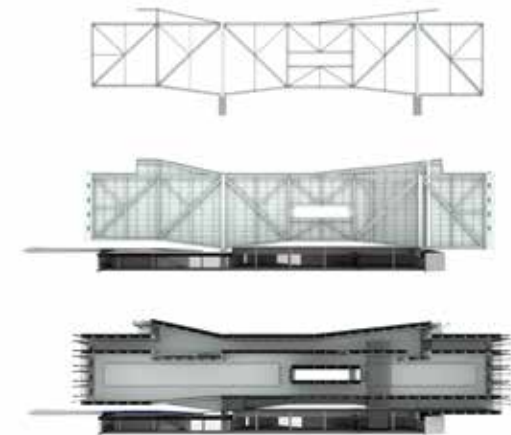

- ① C1 - 40x40x4
- ② C2 - 40x40x4
- ③ C3 - 40x40x4
- ④ C4 - 40x40x4
- ⑤ C5 - 40x40x4
- ⑥ C6 - 40x40x4
- ⑦ C7 - 40x40x4
- ⑧ C8 - 40x40x4
- ⑨ C9 - 40x40x4
- ⑩ C10 - 40x40x4
- ⑪ C11 - 40x40x4
- ⑫ C12 - 40x40x4
- ⑬ C13 - 40x40x4
- ⑭ C14 - 40x40x4
- ⑮ C15 - 40x40x4
- ⑯ C16 - 40x40x4
- ⑰ C17 - 40x40x4
- ⑱ C18 - 40x40x4
- ⑲ C19 - 40x40x4
- ⑳ C20 - 40x40x4

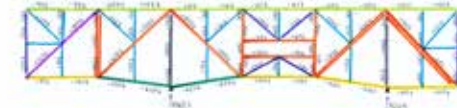

→ GÜVENLİ KÖKLEME İÇİ ÖZGÜN KESİP  
 (1/200) ÇİZİMİYLE, İZİN ALINILMIŞ  
 KULLANILAN ÇELİK YAPI SİSTEMİNE GÖRE

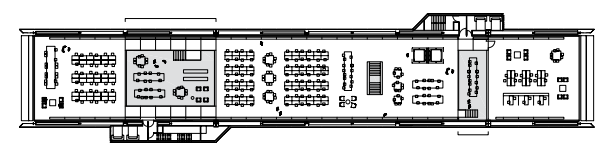
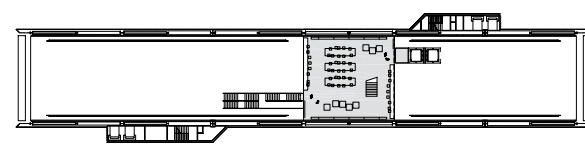
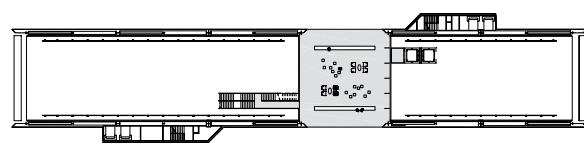



# NATIVIDADE CHURCH [competition entry]

2009, Mexico, Culiacan

ARCHITECTURE Angelo Bucci, João Paulo Meirelles de Faria, Nilton Suenaga









**MOREIRA SALLES INSTITUTE [competition entry]**

2011 São Paulo, SP

**ARCHITECTURE** Angelo Bucci

**TEAM** Ciro Miguel, Giovanni Meirelles, Juliana Braga, Nilton Suenaga, Tatiana Ozzetti

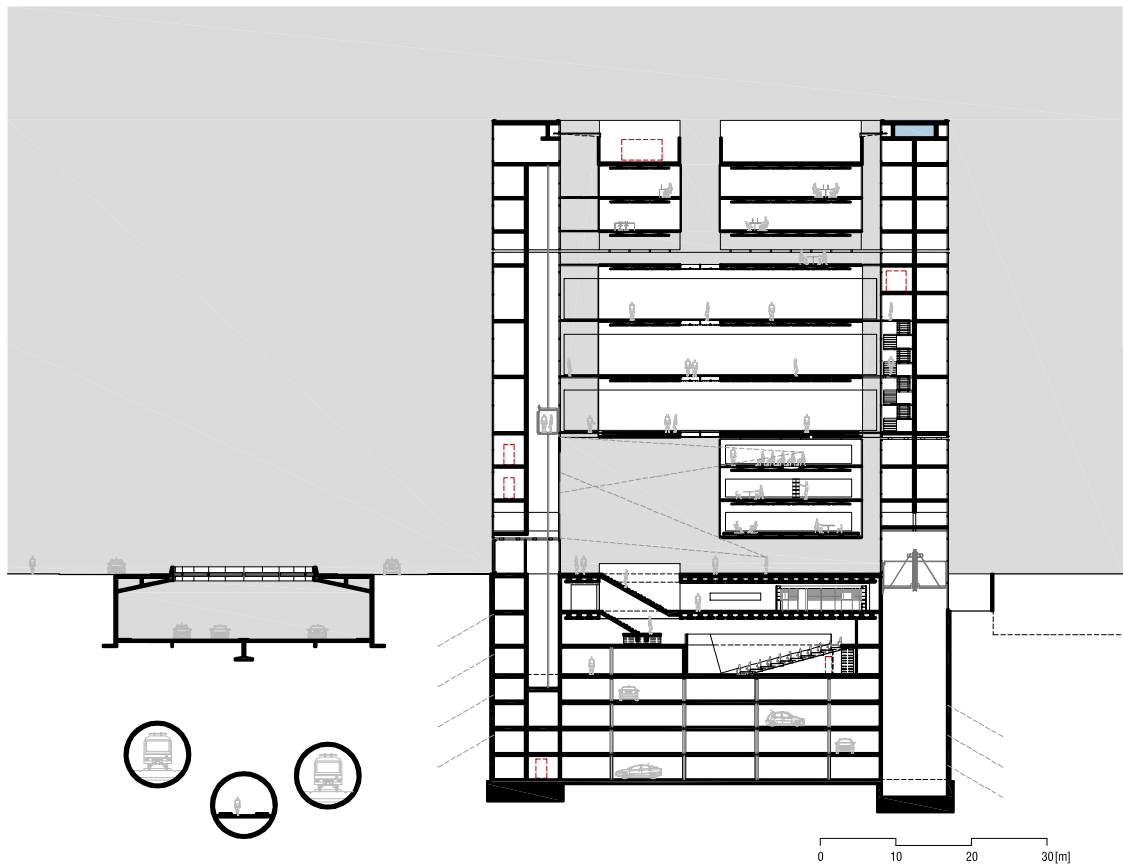
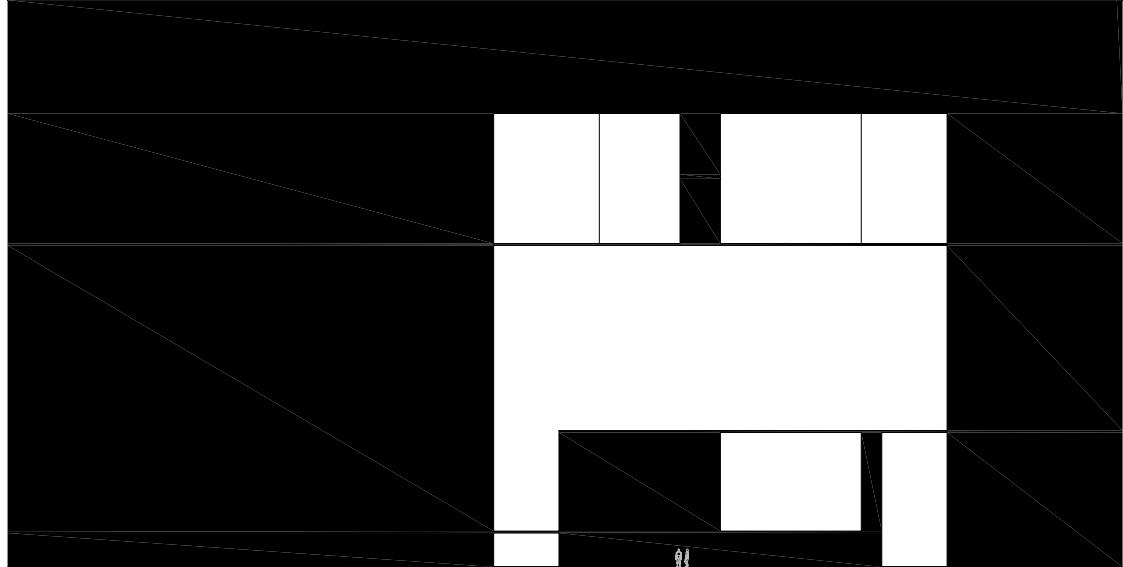



# WINNERY AT SÃO JOSÉ DO RIO PRETO

2012-2013 São José do Rio Preto, SP

**ARCHITECTURE** Angelo Bucci

**DESIGN TEAM** Ciro Miguel, Juliana Braga, Nilton Suenaga, Tatiana Ozzetti, Víctor Próspero



