

module08_blech

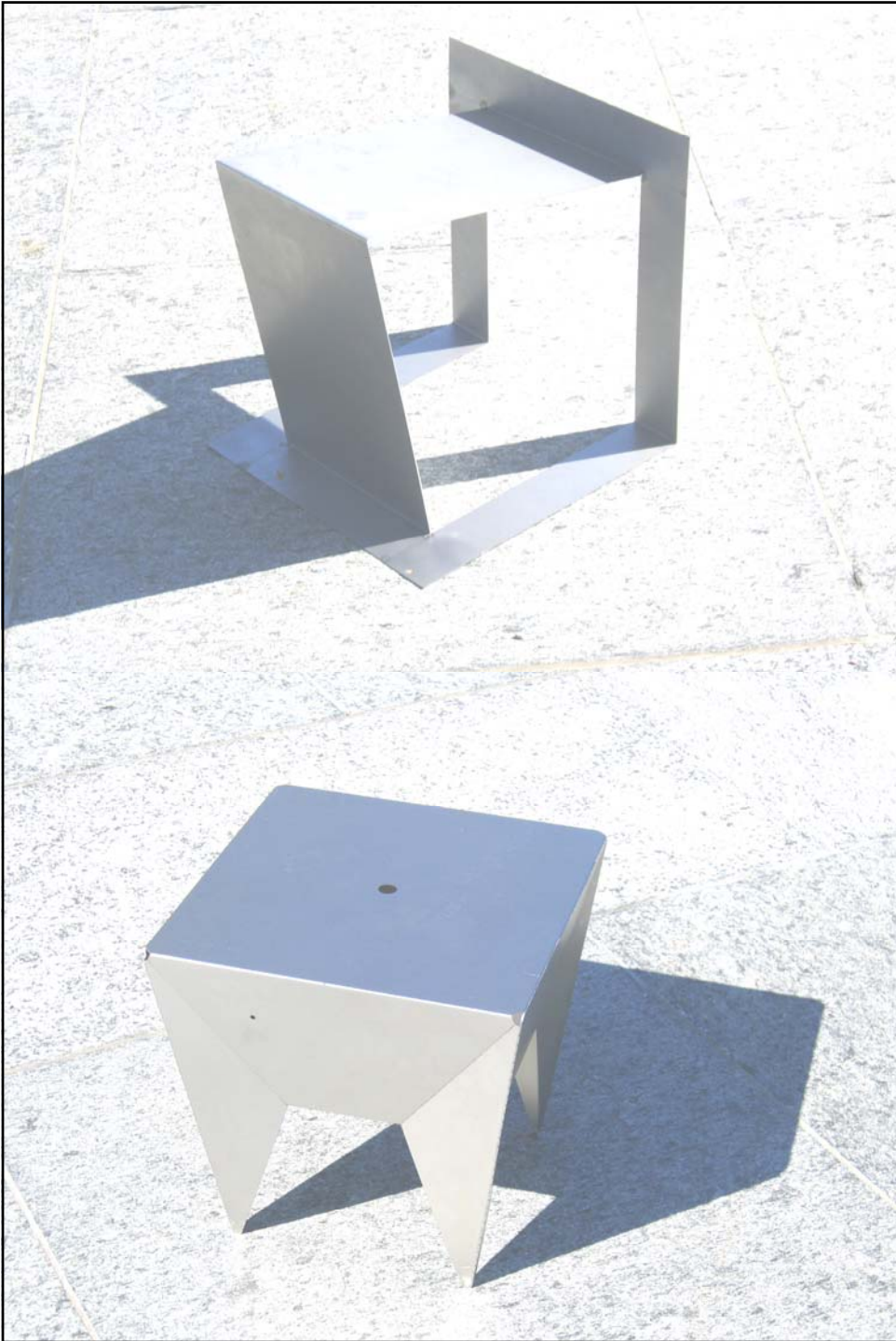

assignment01

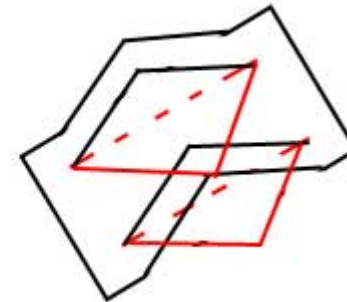
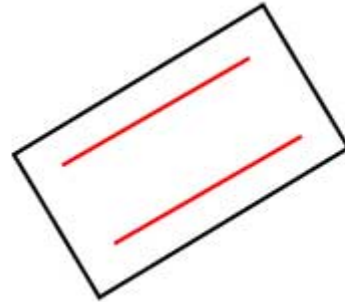
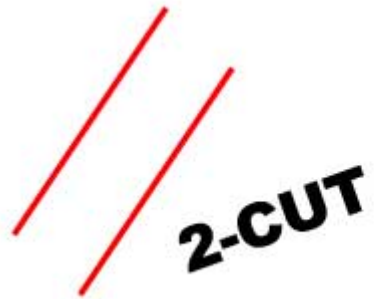

- > 1 piece
- > 3 cuts (contour – 2 lines)
- > 1 bending (3 bending axes)

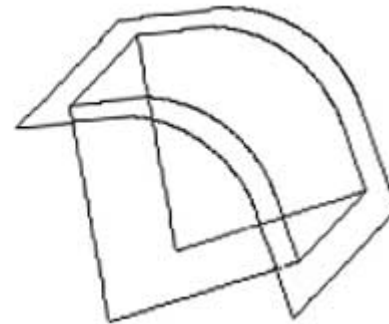
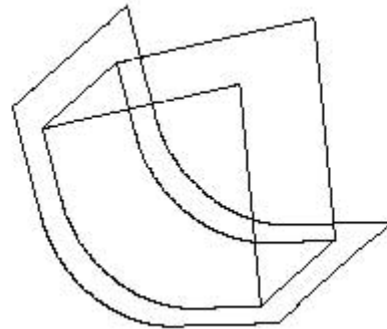
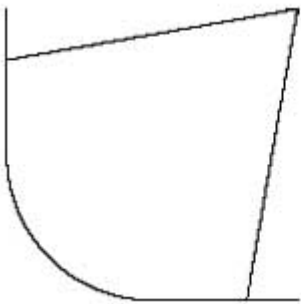
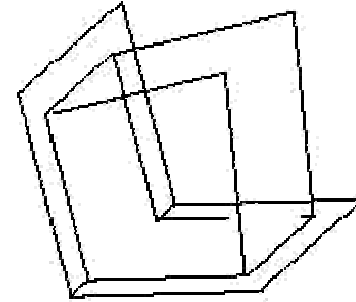
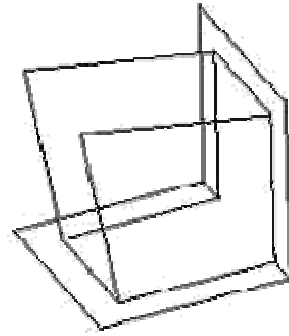
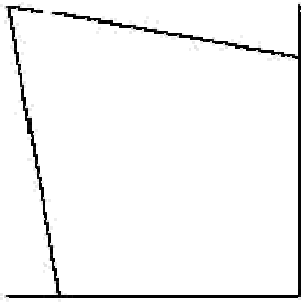



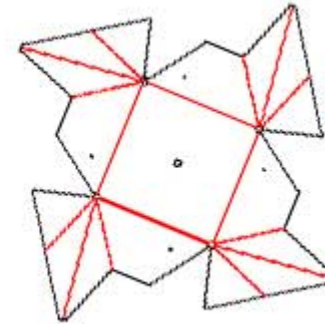
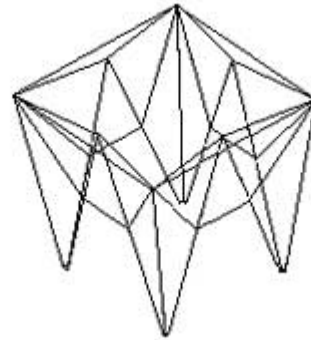

-> 1 piece

-> 1 cut – folding axes

-> delivered as a plate – folded by hand by the client (*“origami”*)





assignment02

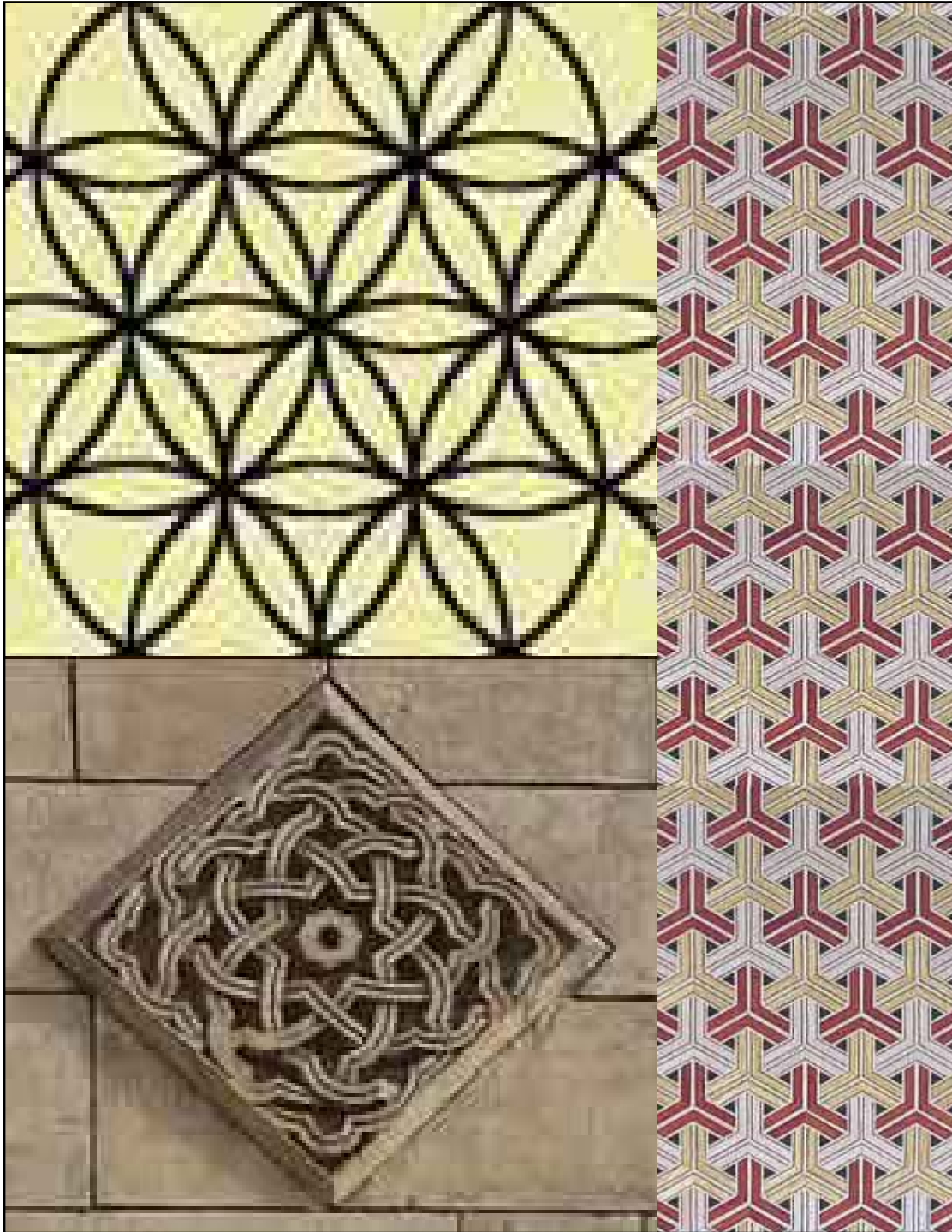

geometrical patterns

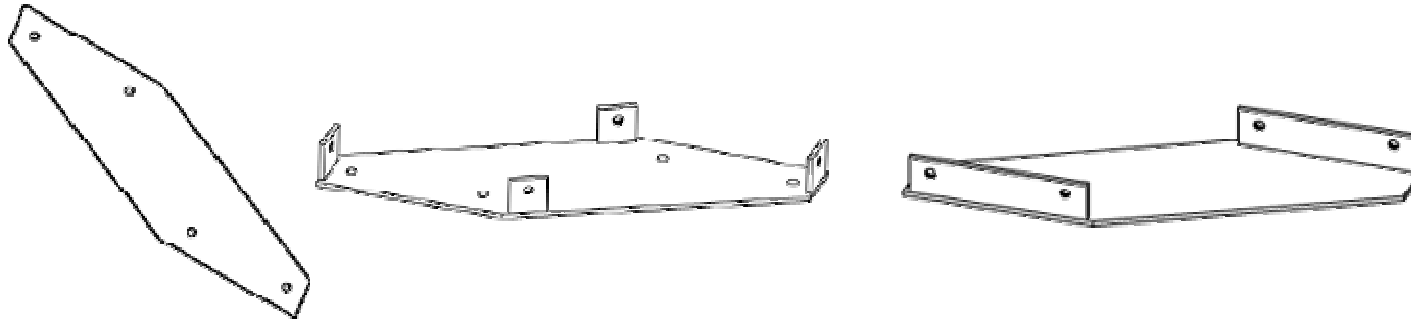

- > *"trumpf alphabet"*
- > ready-made by the machine (no after bending, ...)
- > 1 geometrical form – different flanges
- > positive – negative pieces
- > different patterns/figures

